

**CO-
HAB
RAVAL**



FIRST PHASE. EXISTING SPACES

Site visits and fieldwork in El Raval neighbourhood









Site visits and fieldwork with the Focus Group



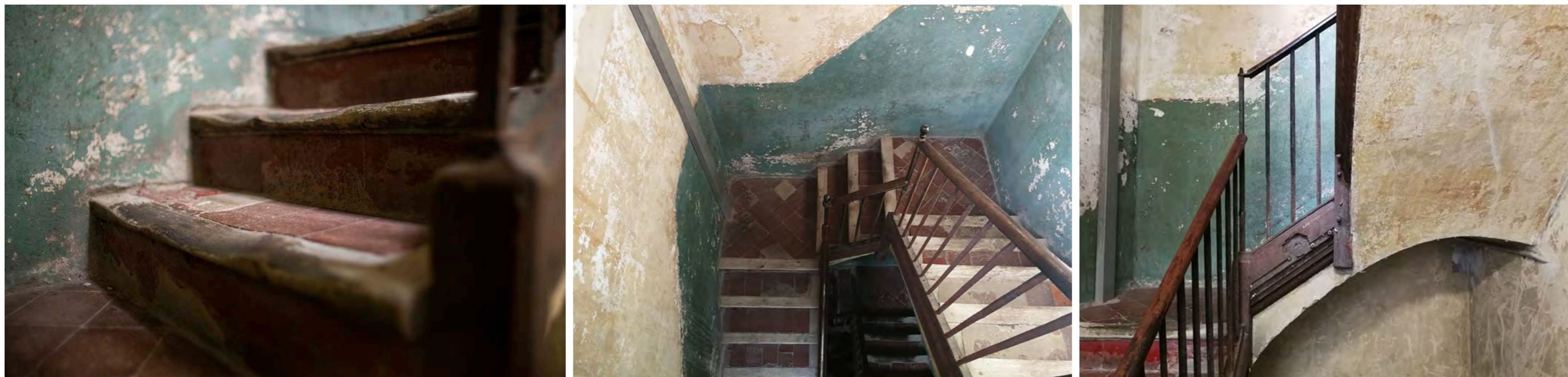

Detection of needs and evaluation of common damages in shared spaces



SECOND PHASE. CO-DESIGN

Preparation and assessment of a Catalogue of micro-projects with residents





Participatory processes with neighbours



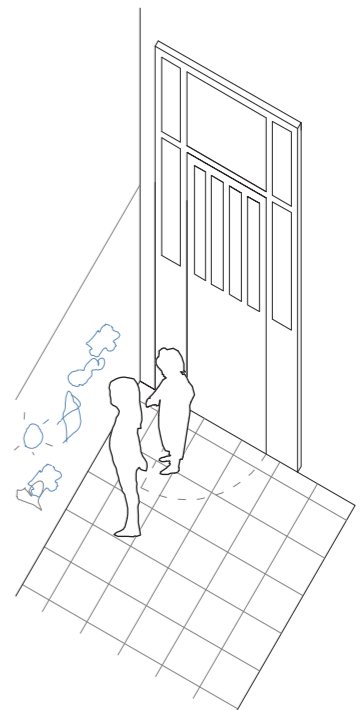
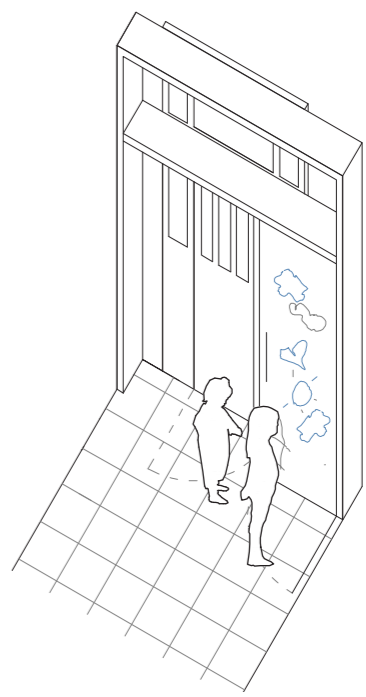
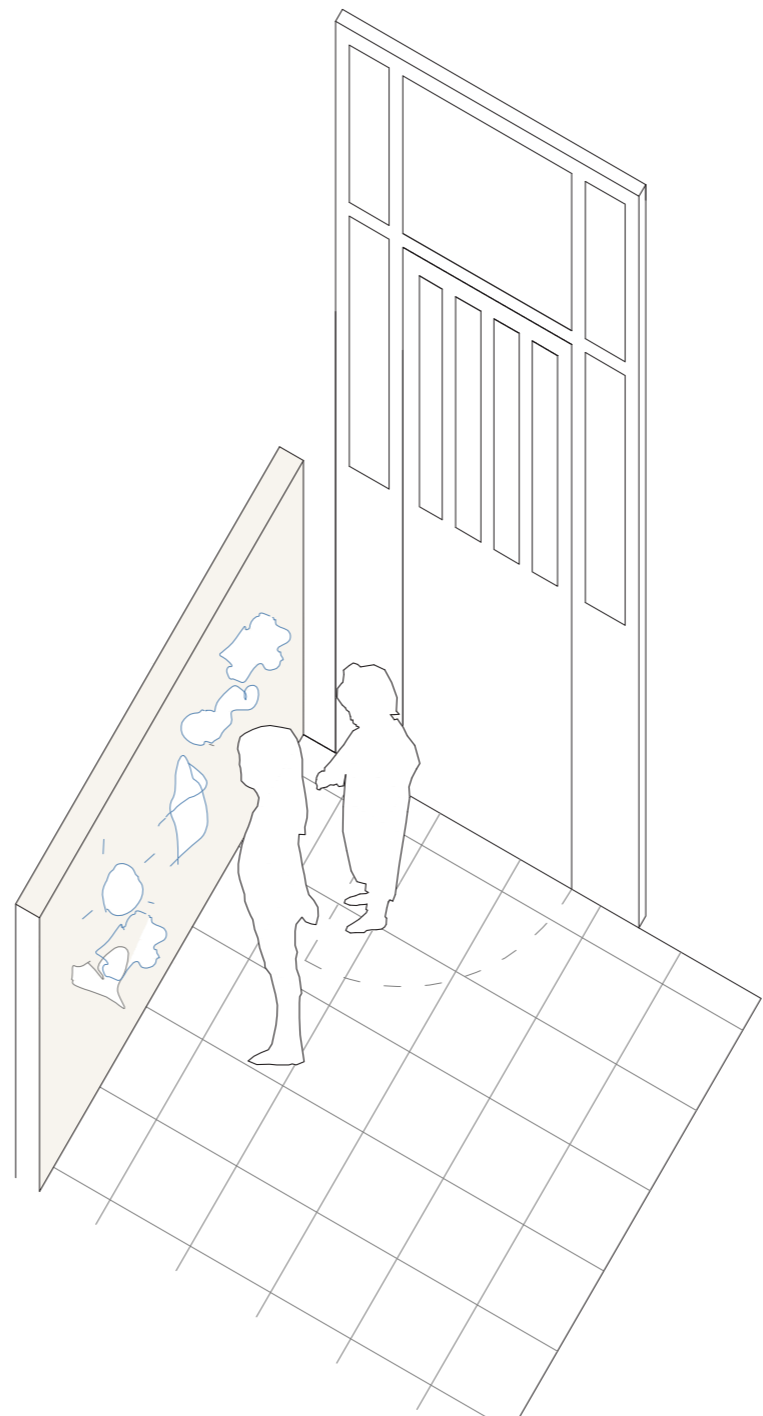
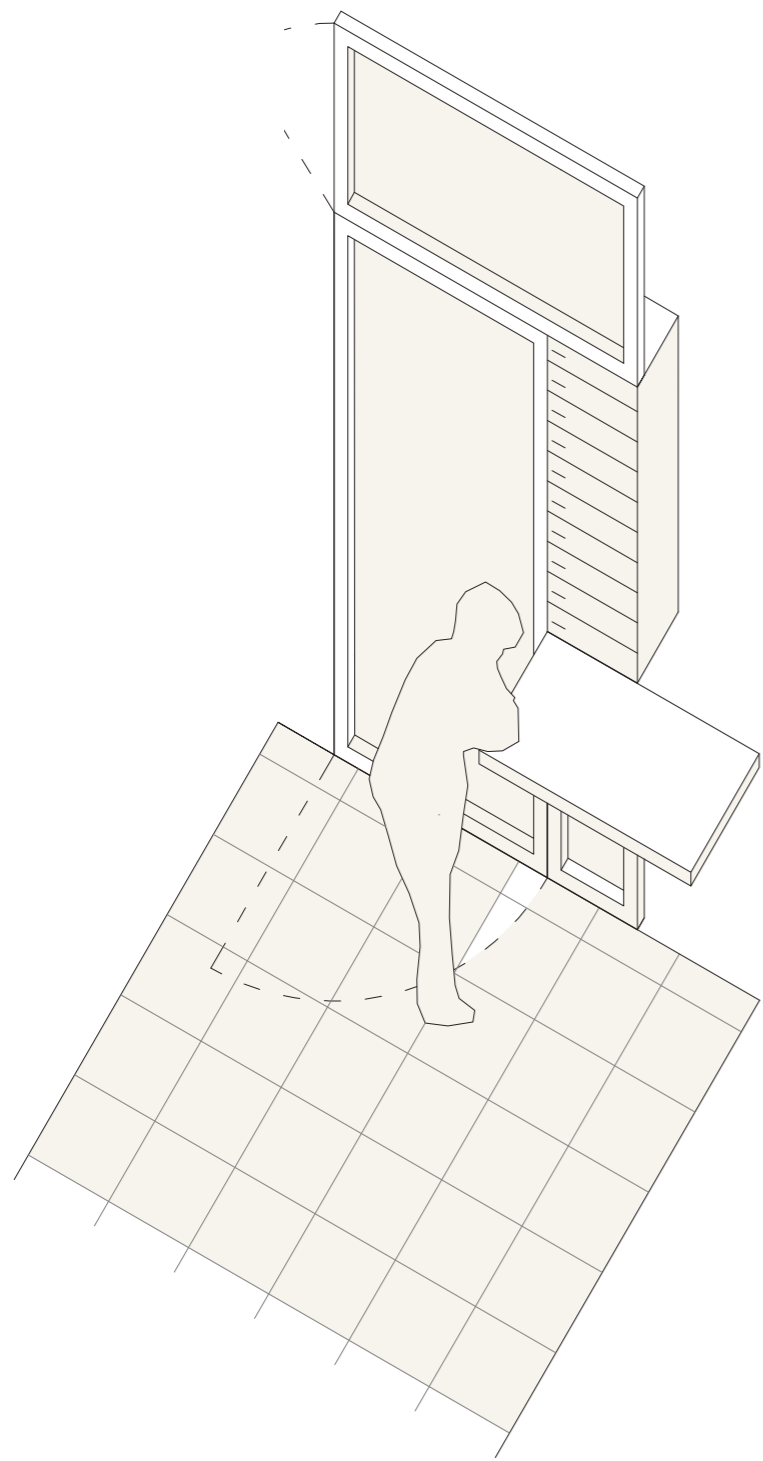

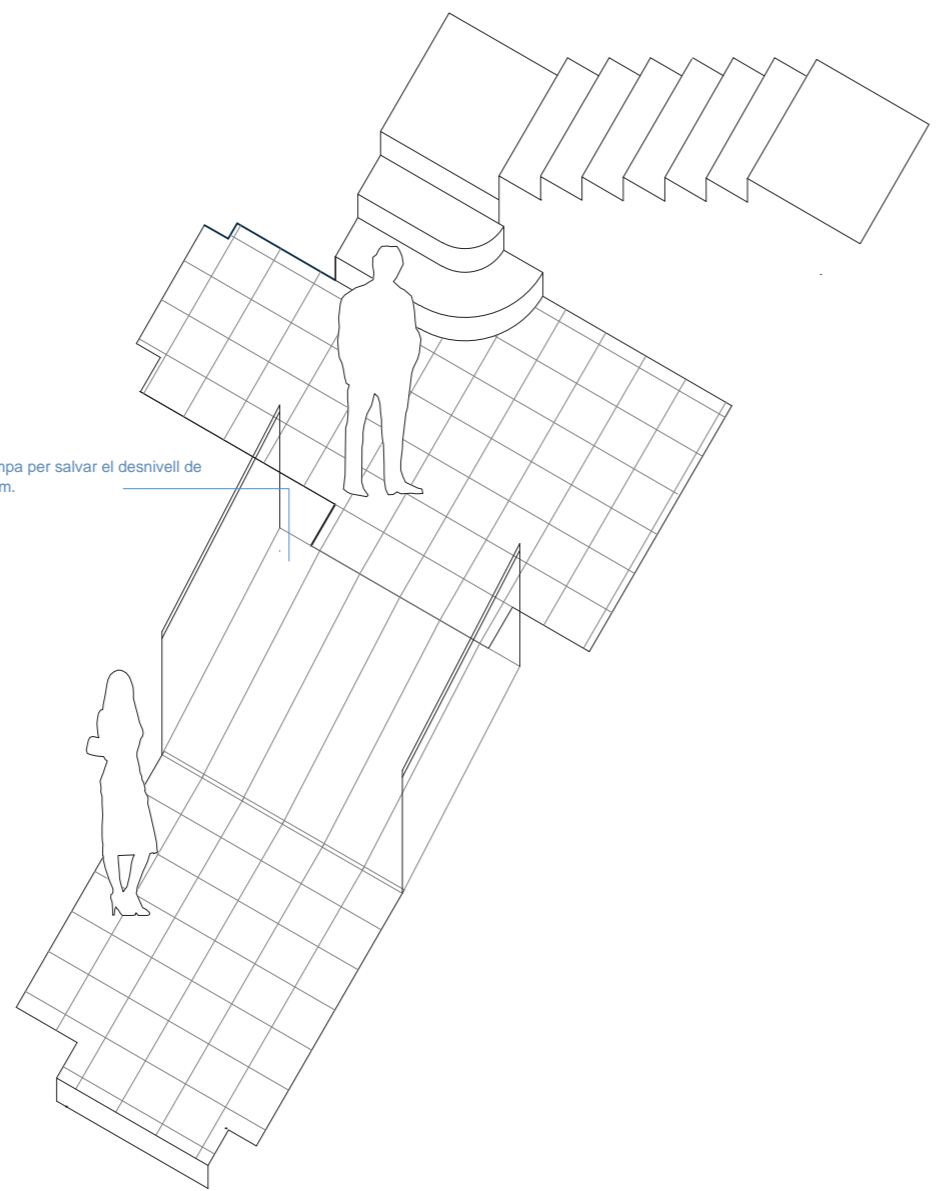
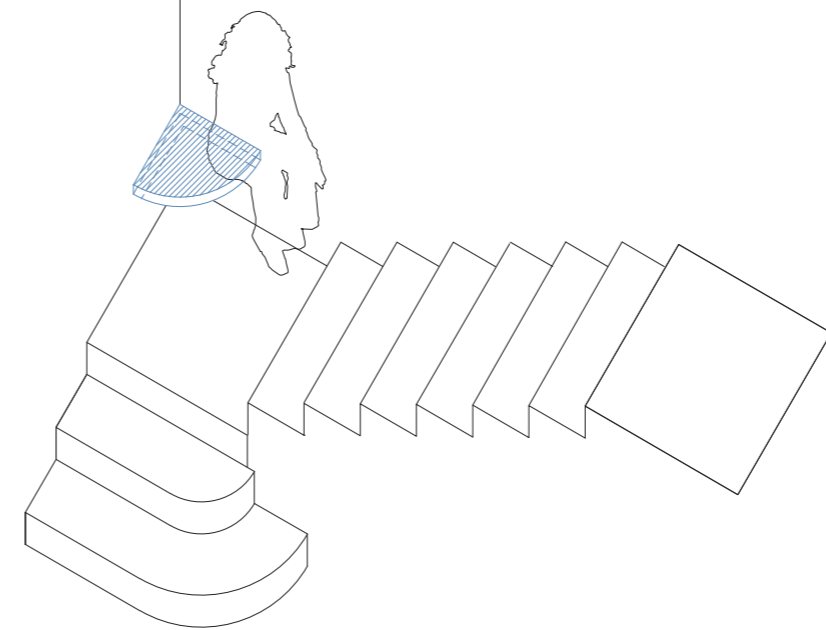
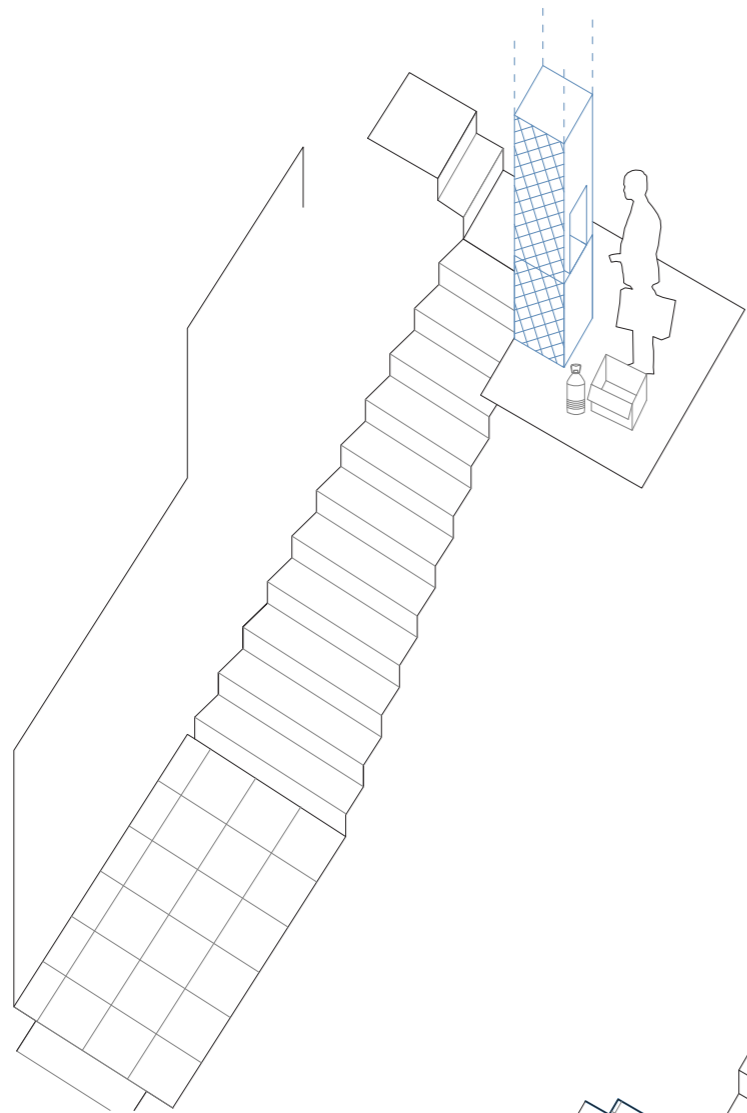

Rampa per salvar el desnivell de 20cm.

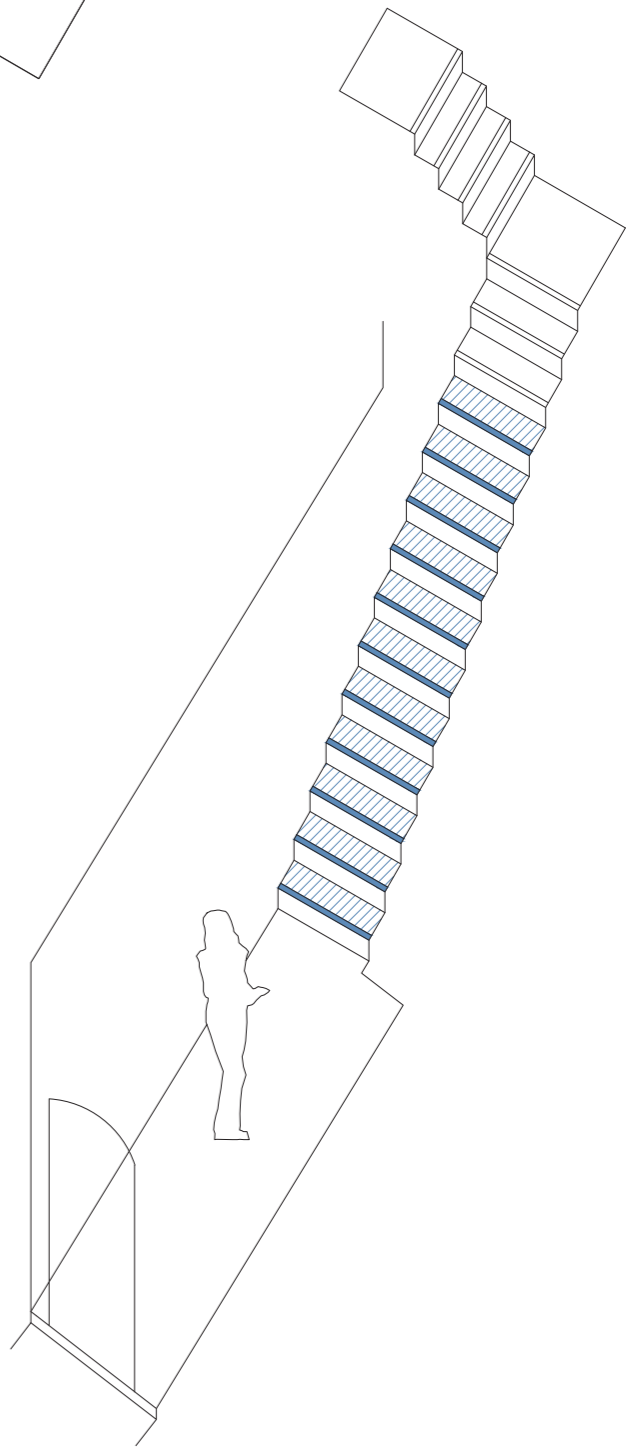

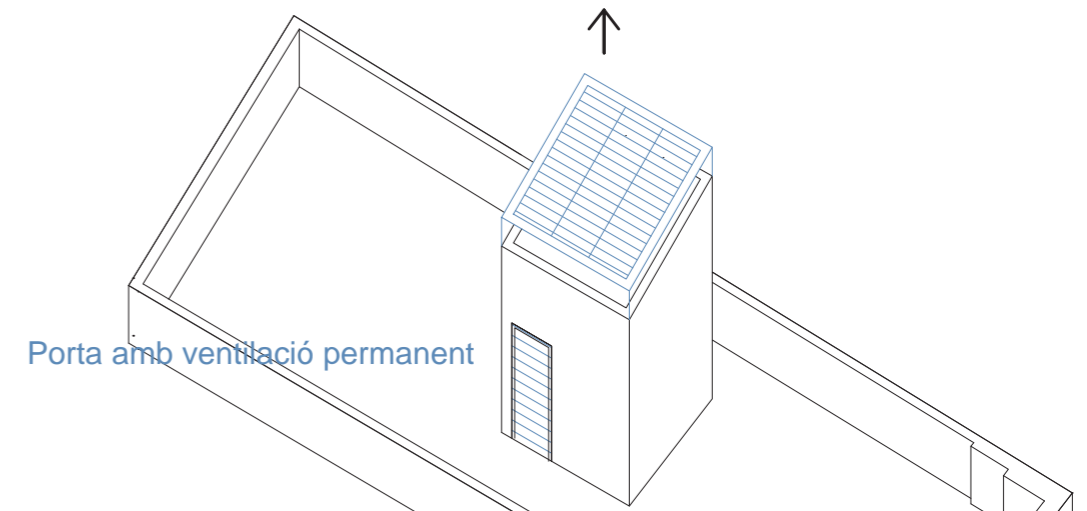
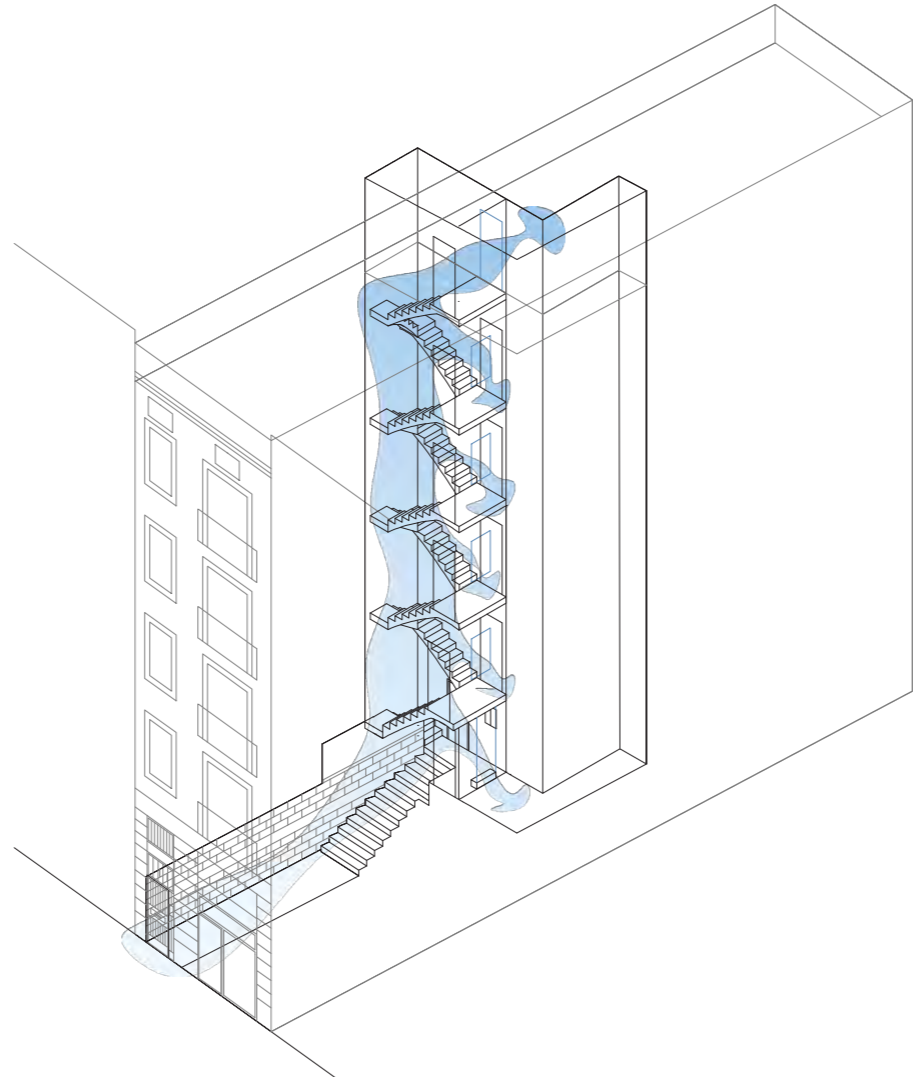
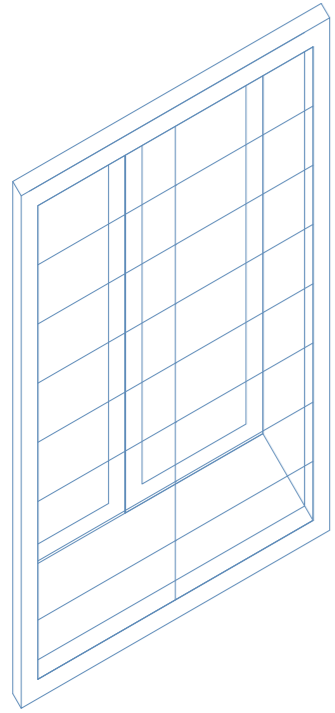

Porta amb ventilació permanent

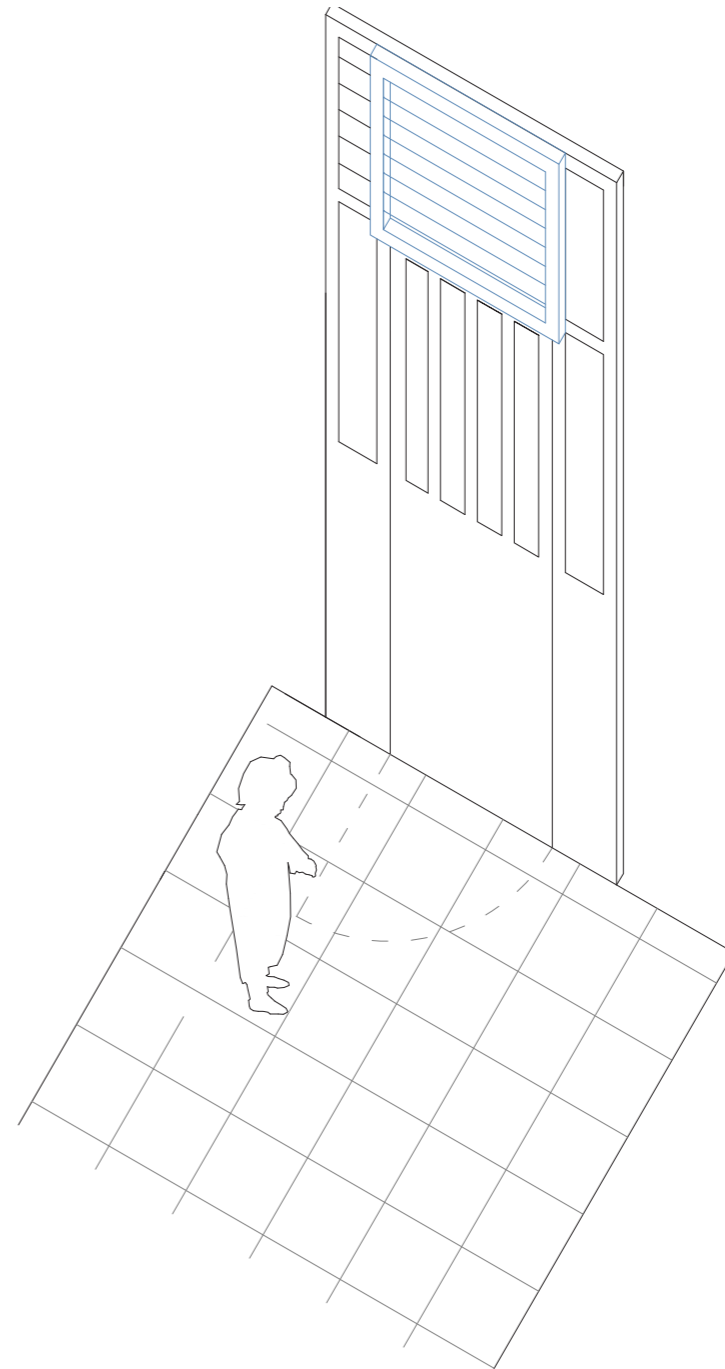
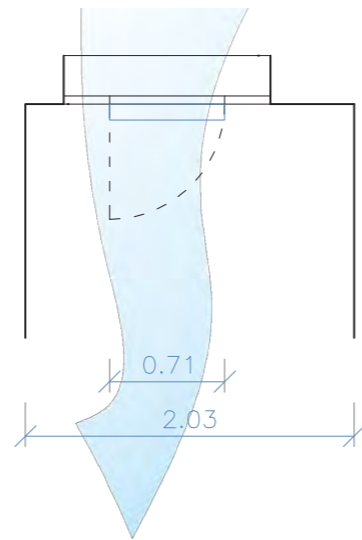
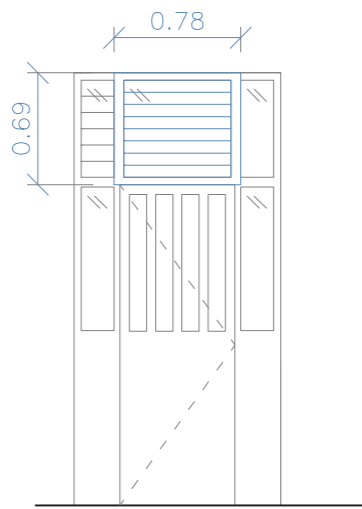

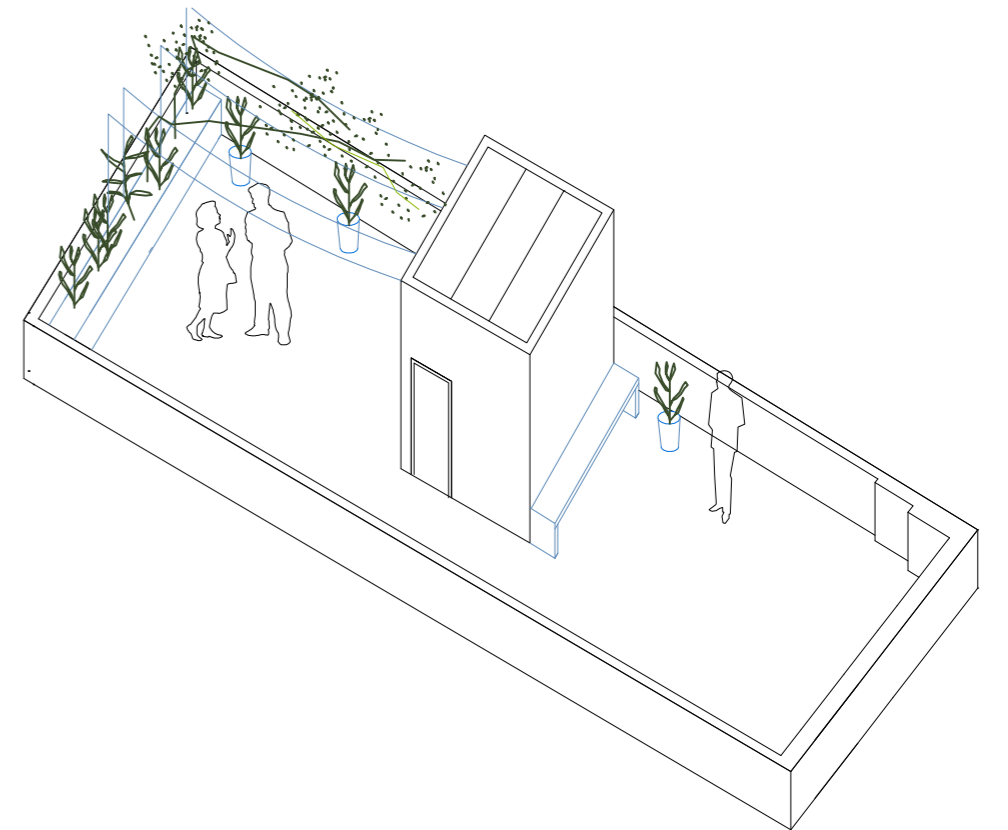
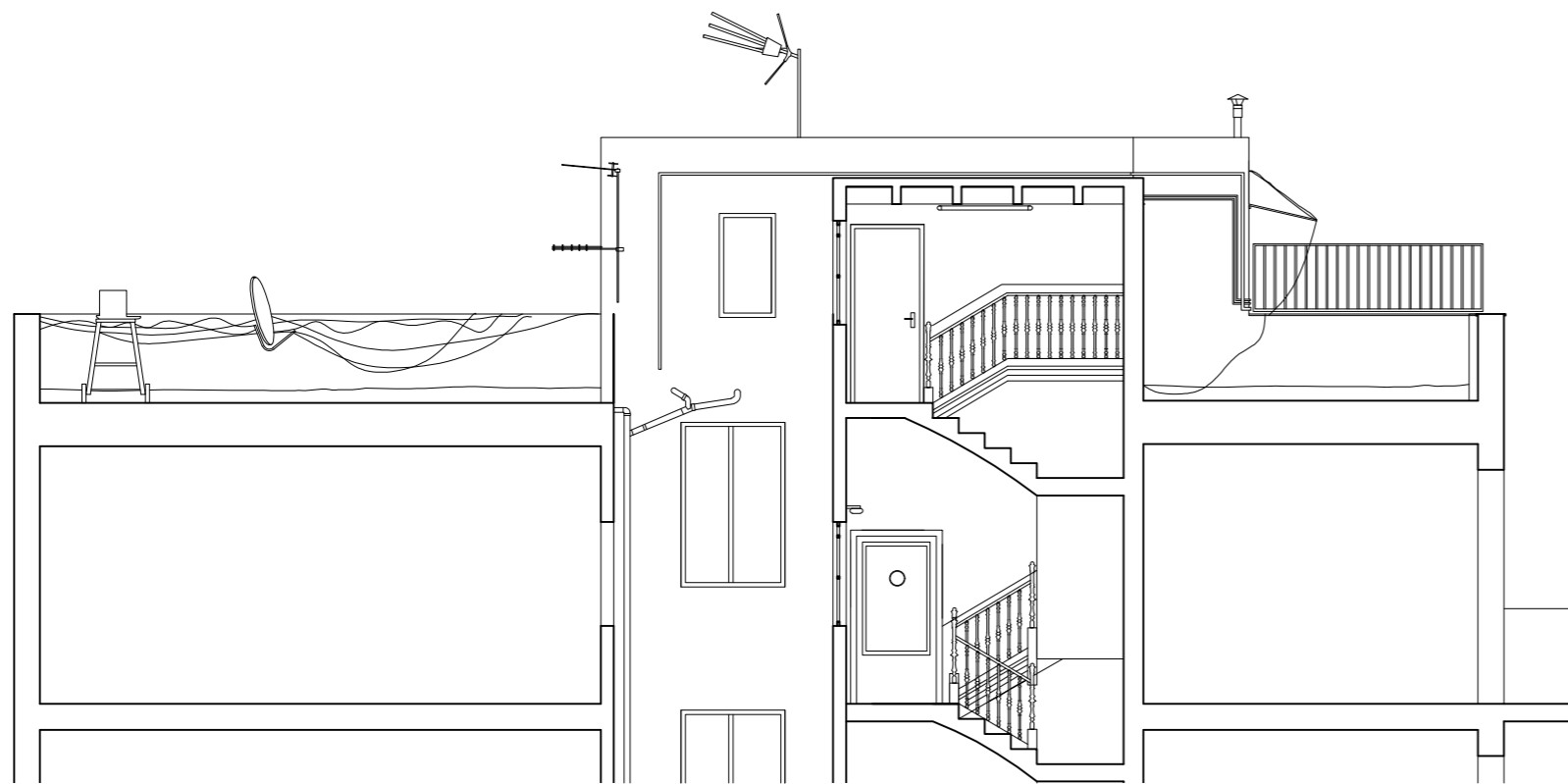
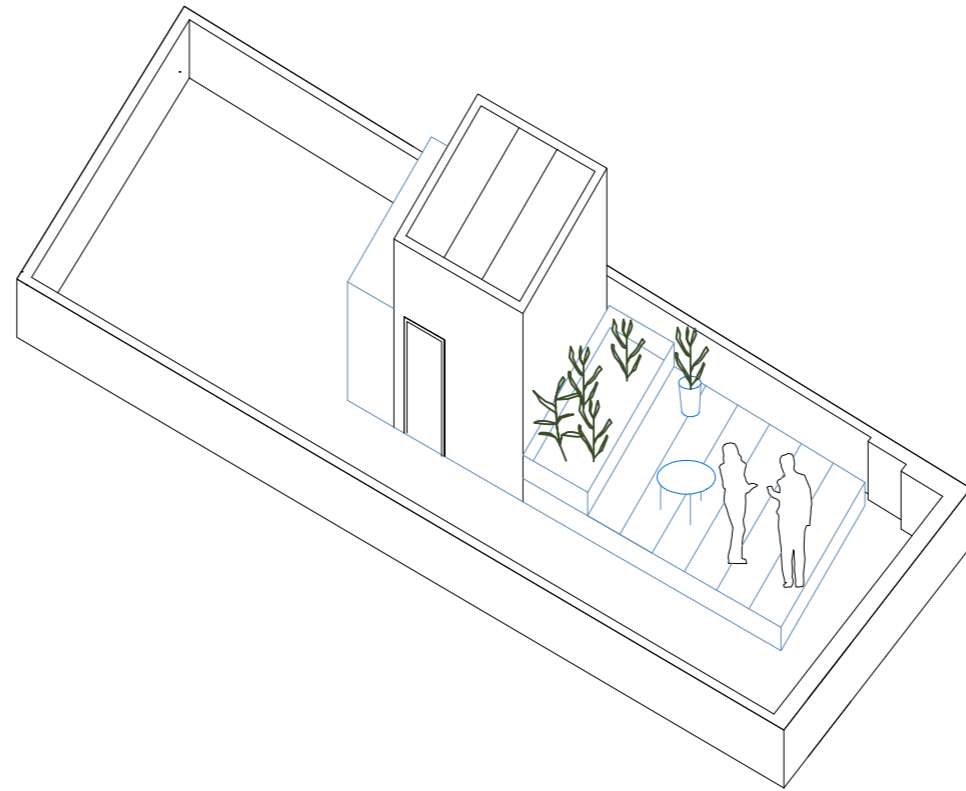
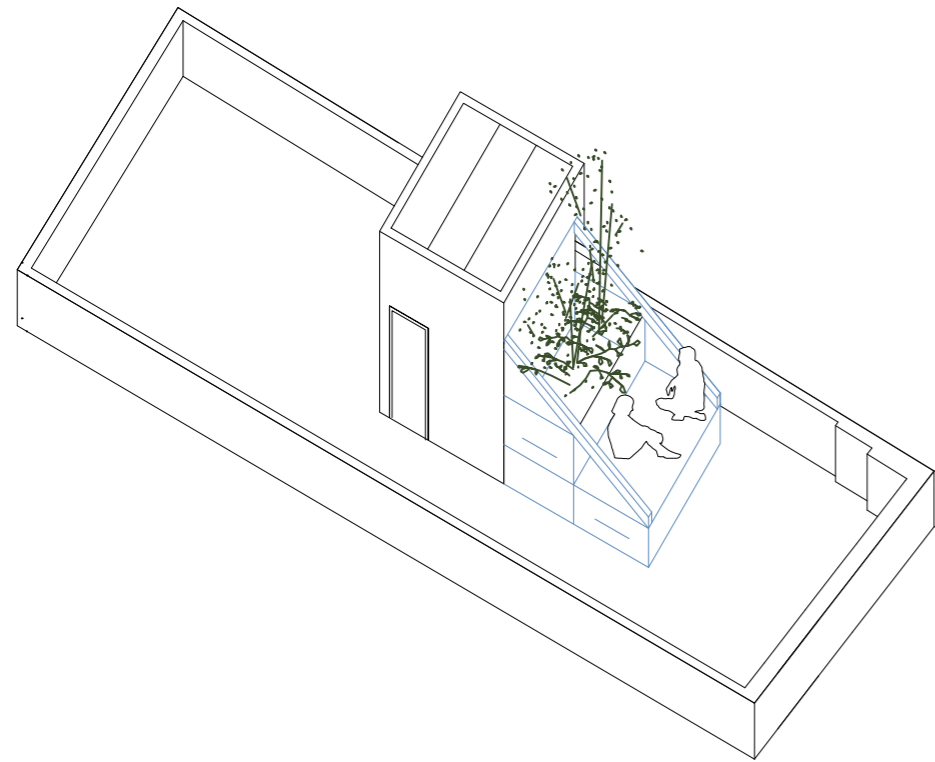



Participatory processes with neighbours





THIRD PHASE. PILOT CO-DESIGN AND DEFFINATION

Academic workshops and participatory processes for the co-design of pilot projects

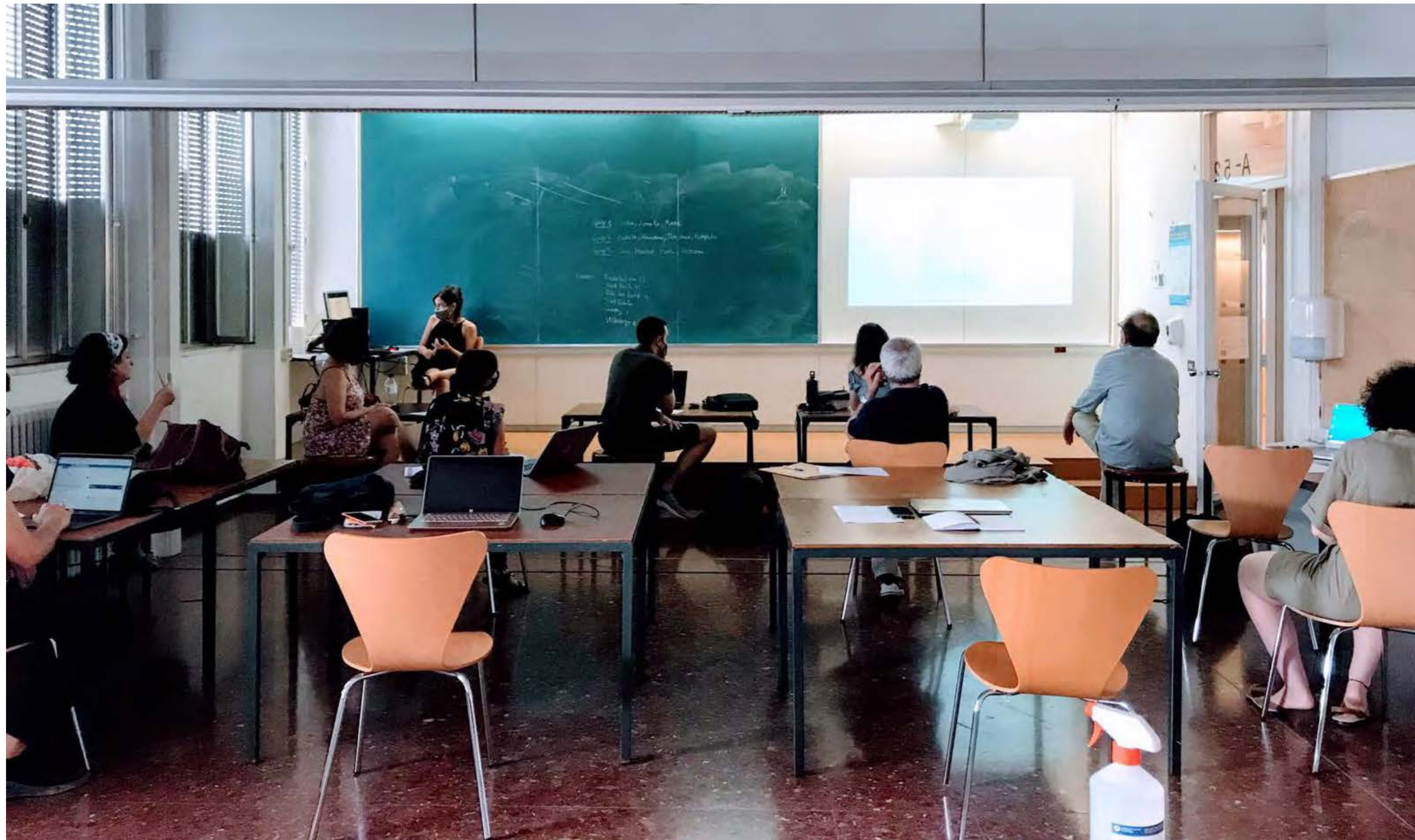

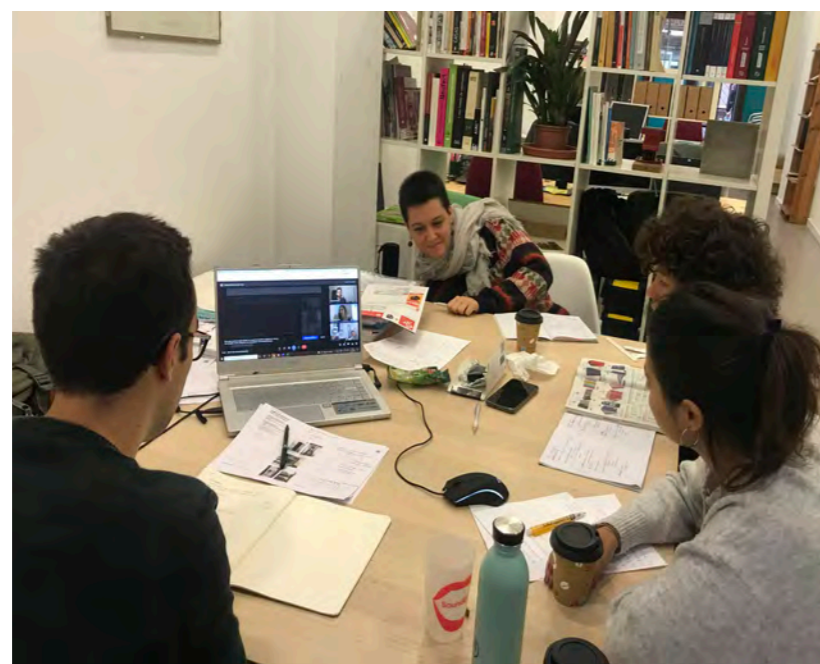

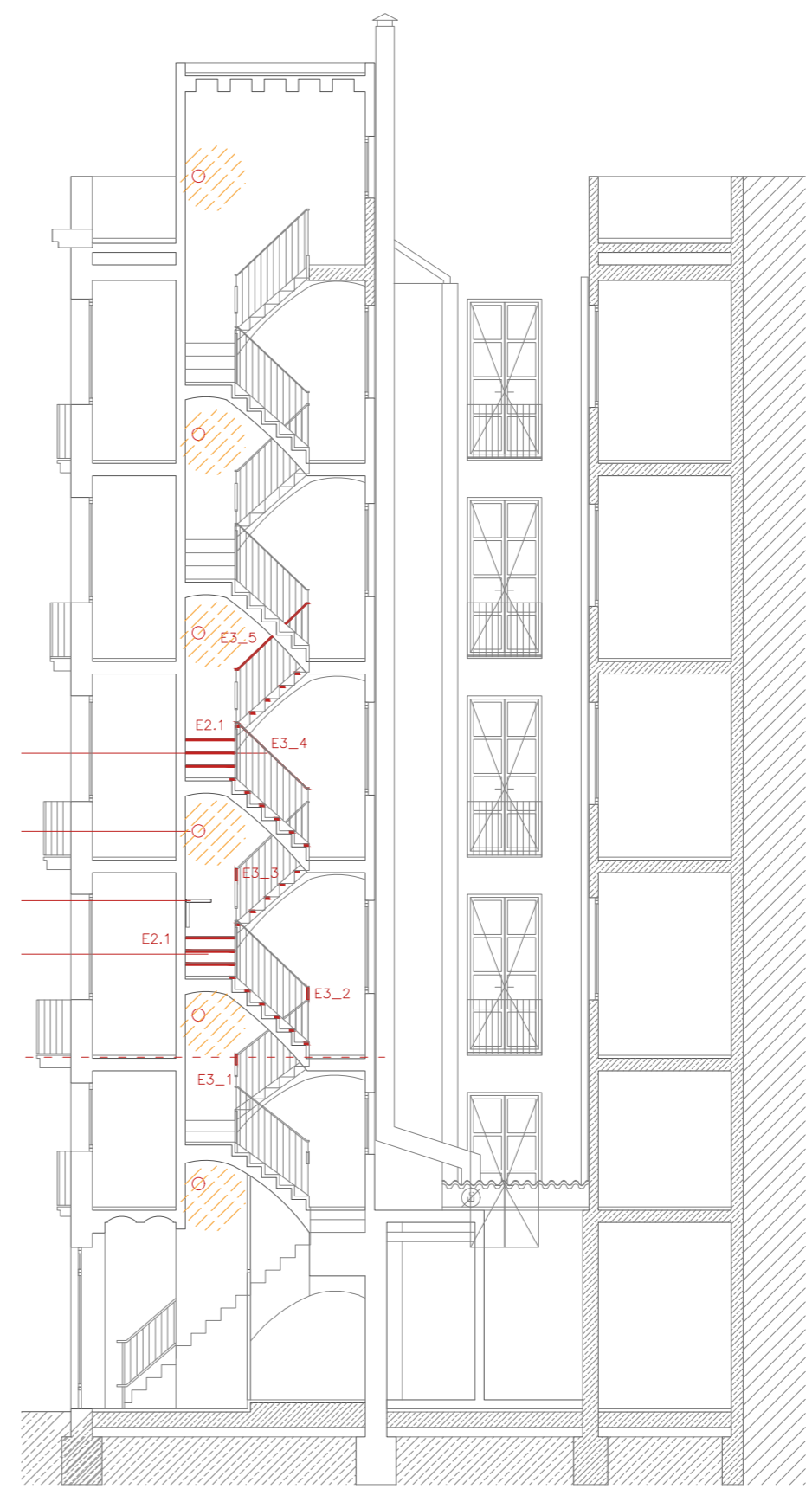
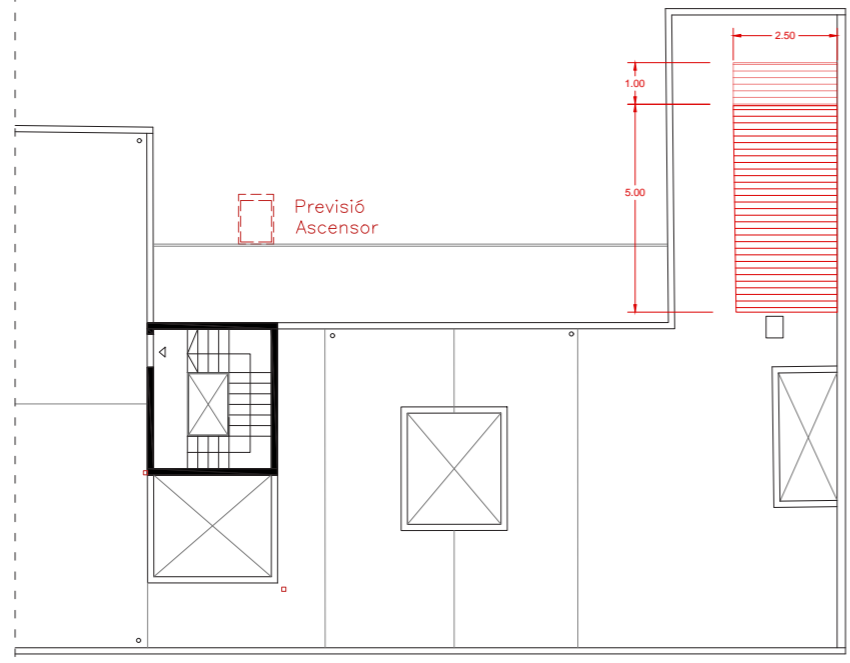
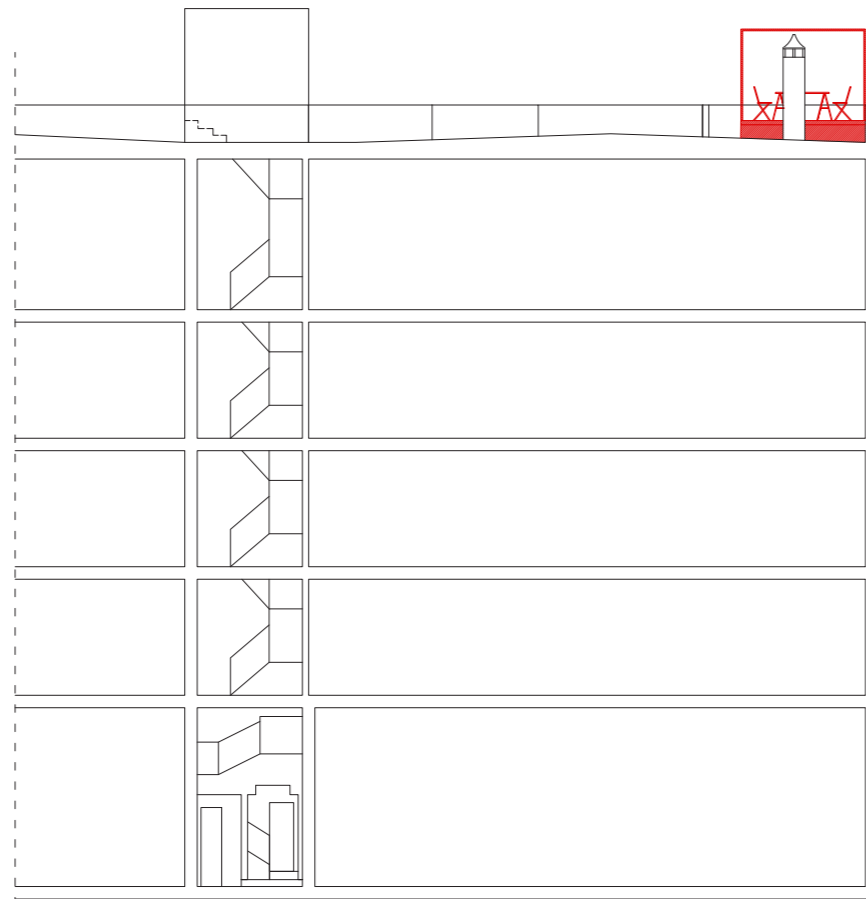

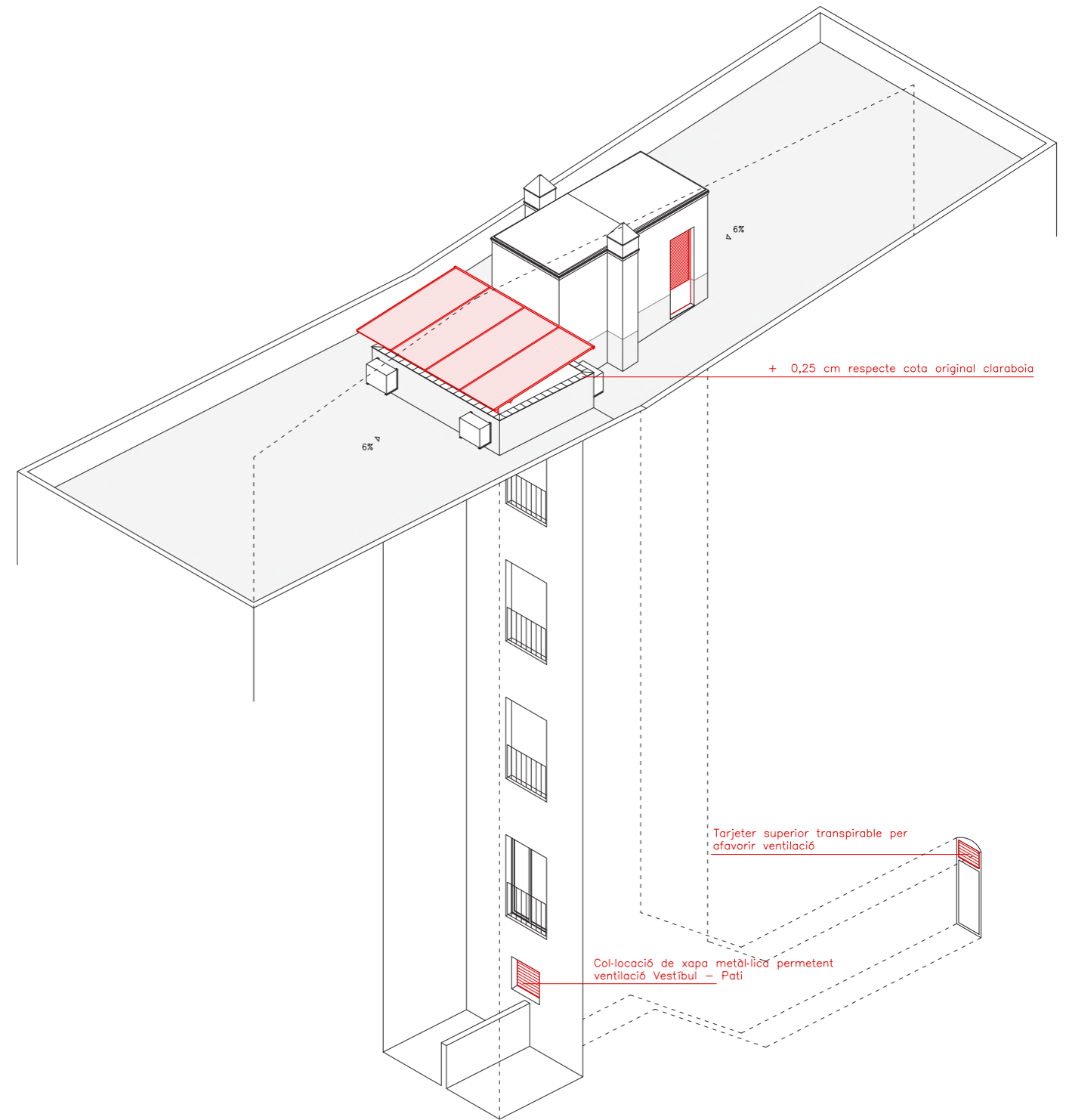
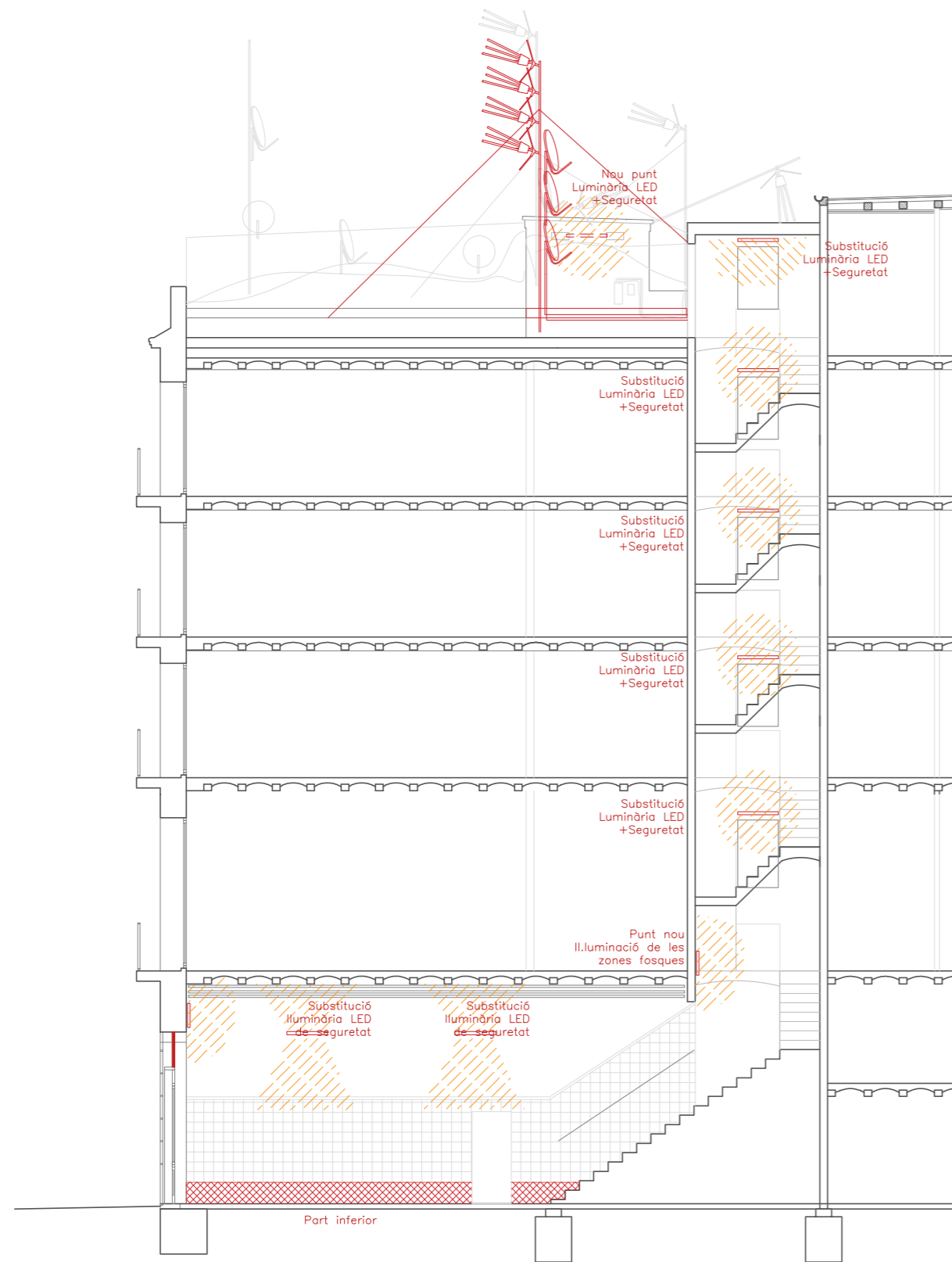

Participatory processes for the selection and adaptation of pilot projects to five communities

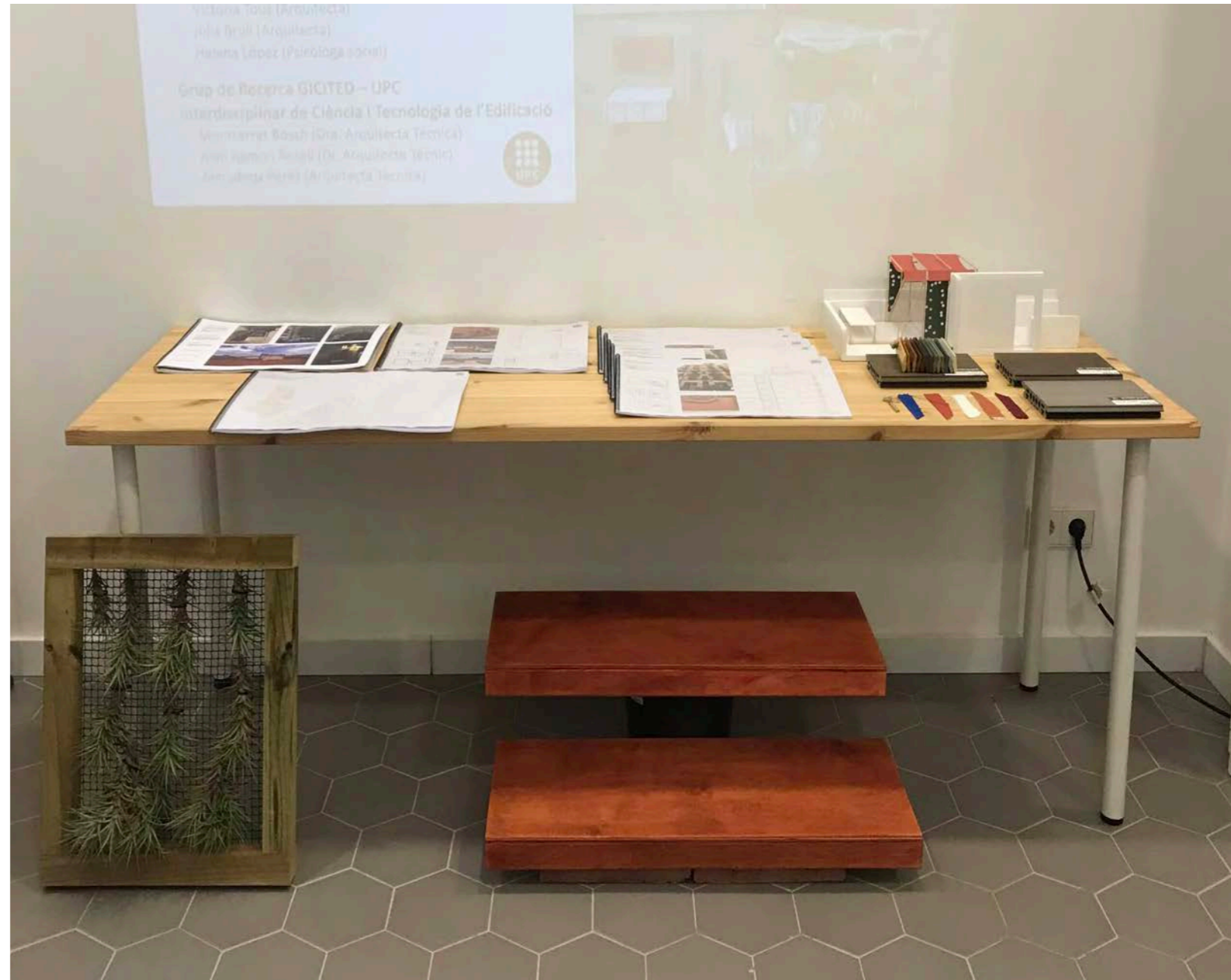



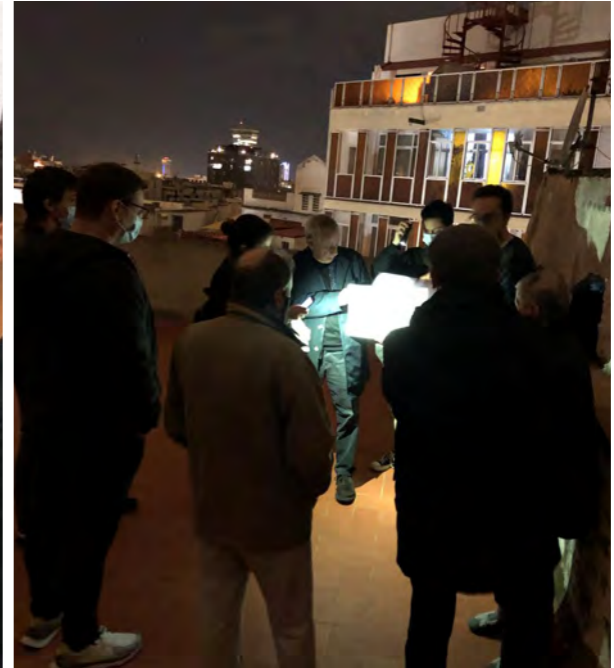

FOURTH PHASE. CO-FABRICATION

On-site implementation and co-fabrication of pilot projects by residents and local professionals



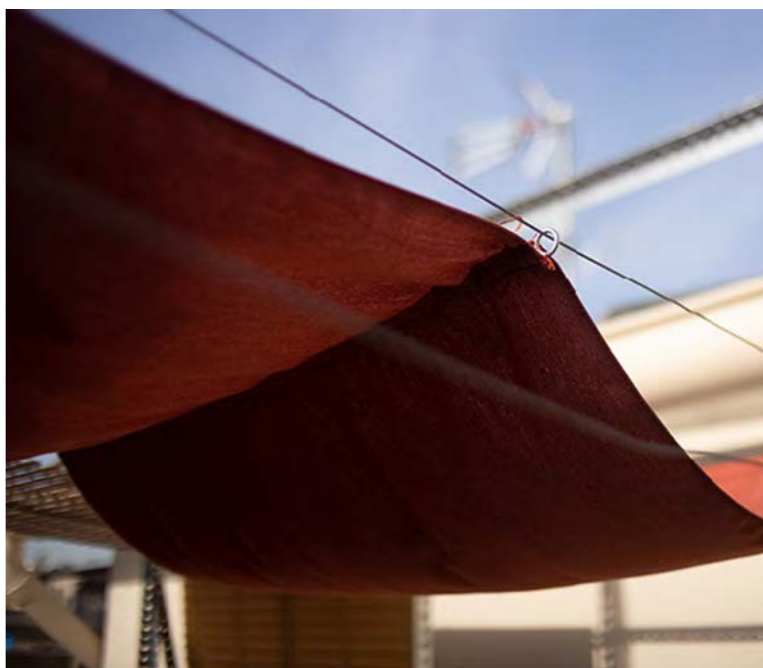

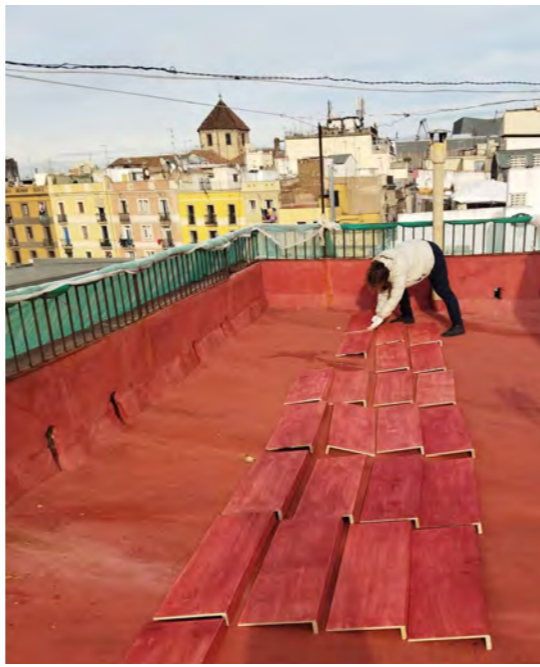
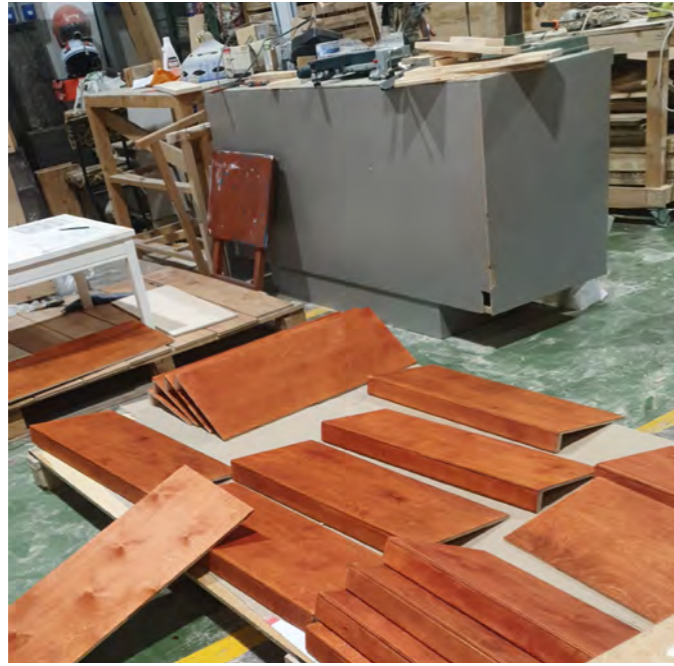

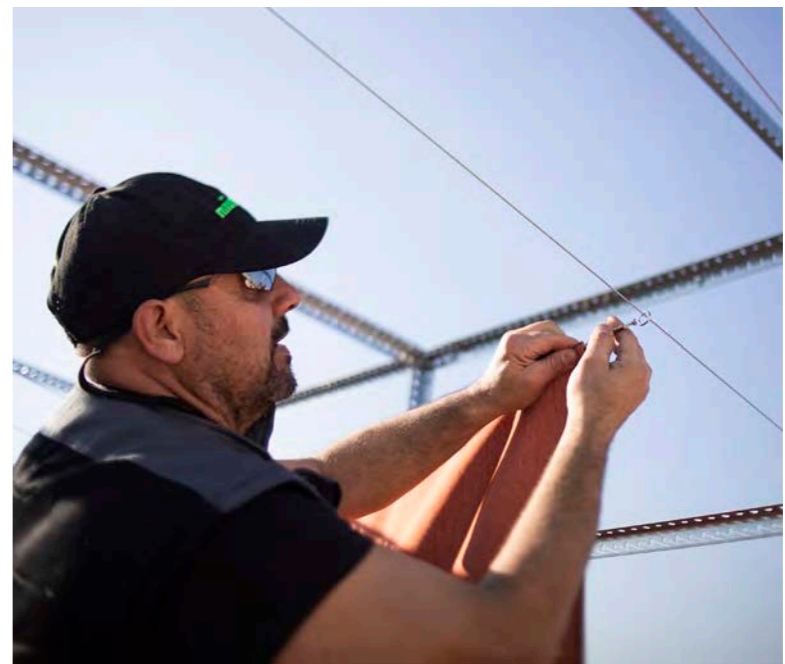

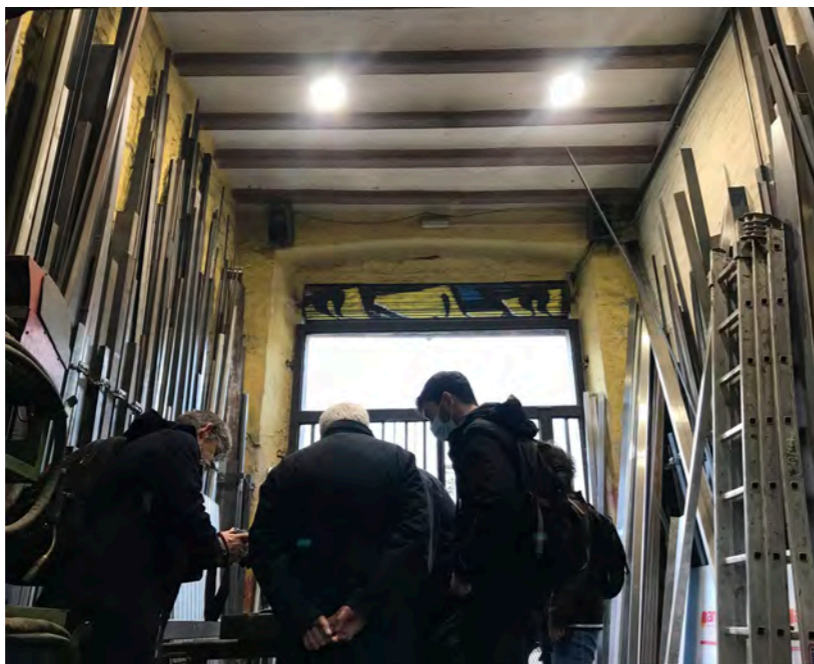
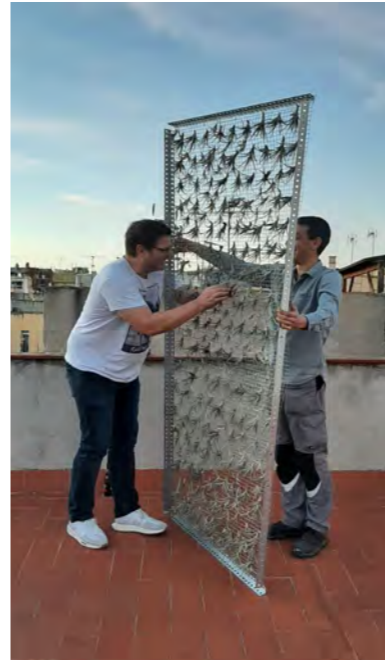

FIFTH PHASE. BUILT PROJECTS

Industrialized components of adjustable size based on dry construction systems that can be adapted to fit different physical supports

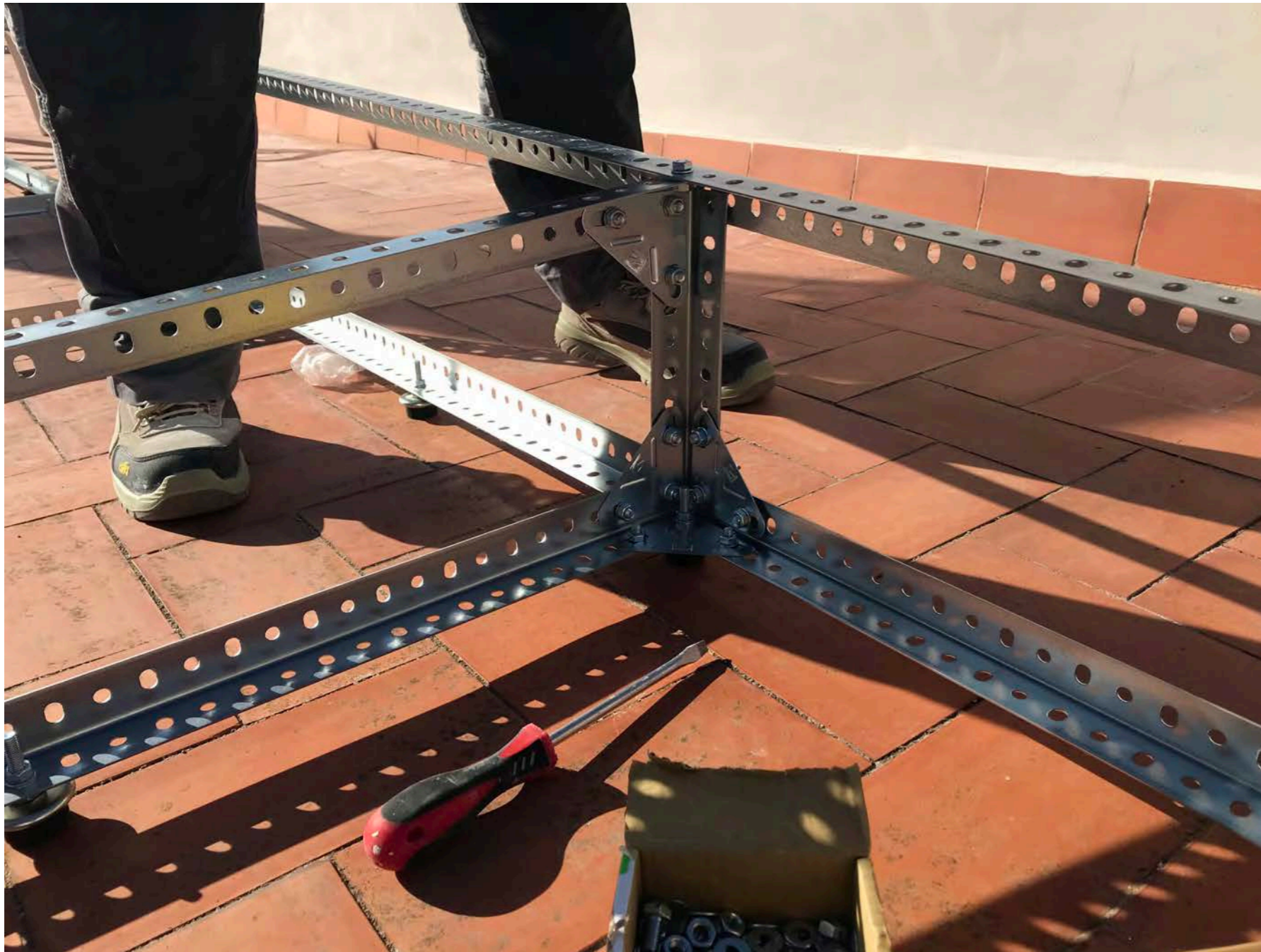

Low-cost perfectible solutions that attach the existing built support without compromising heritage protection

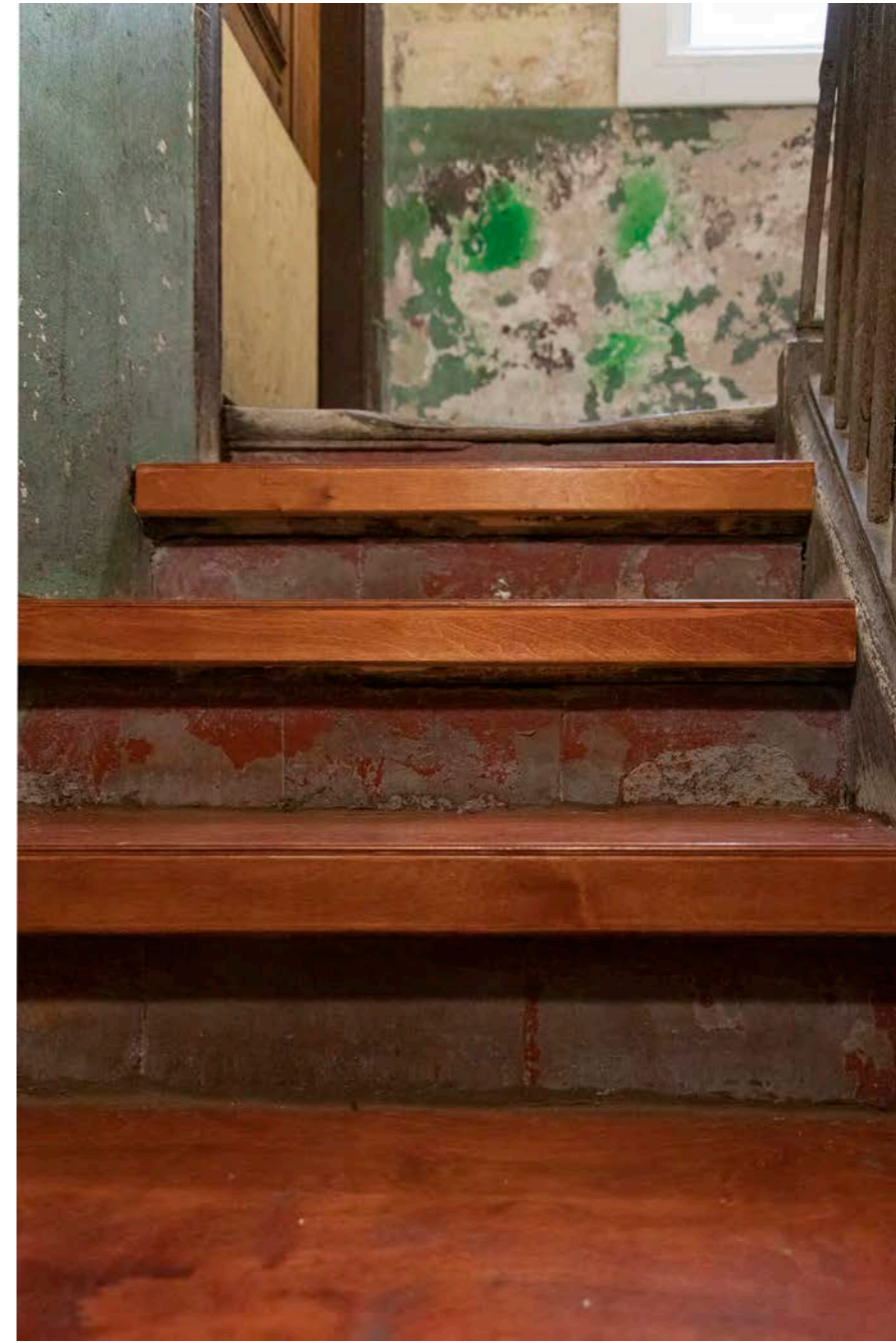

Open structures and designs that incorporate plug-in components and provide an universal base that can admit variable finishings

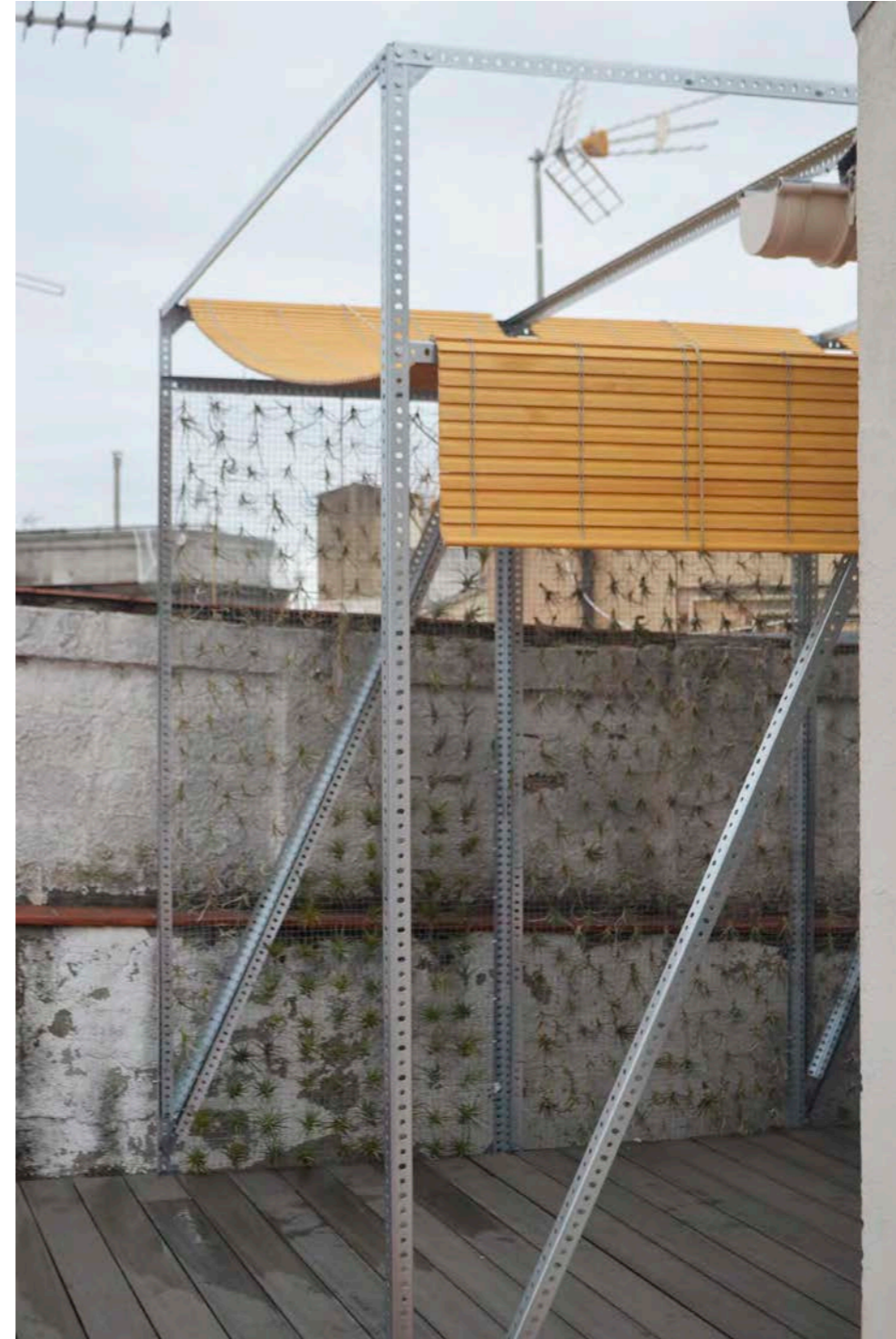



Attachable plug-in components (plants, shades, storage,...) and variability of colours, textures and materials

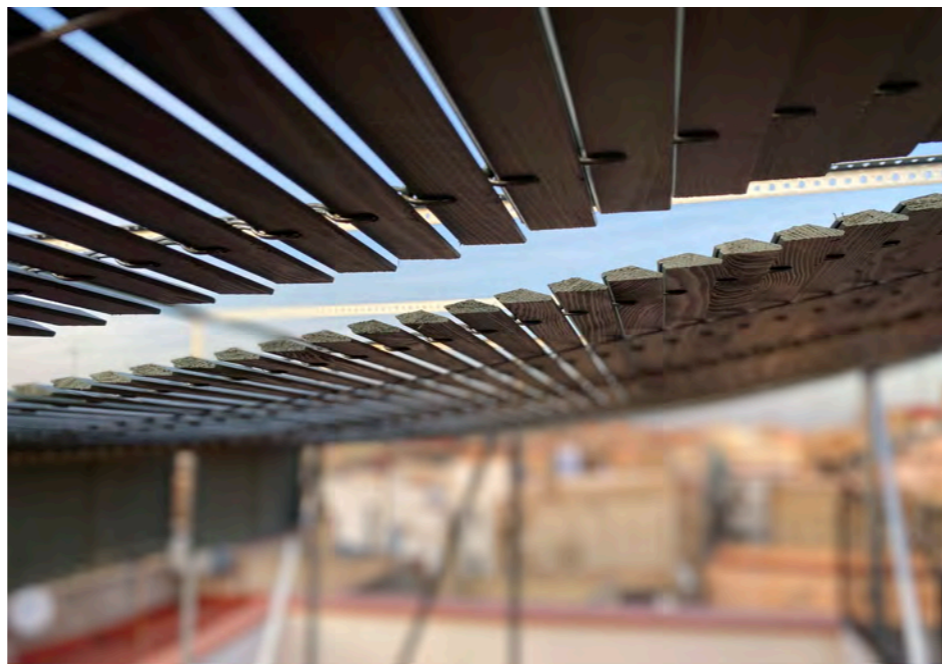

FINAL PHASE. COHABITATION

Habitability, inclusion, accessibility, safety, sustainability, care and health in Sant Ramon and Sant Pacià interventions on the staircase.

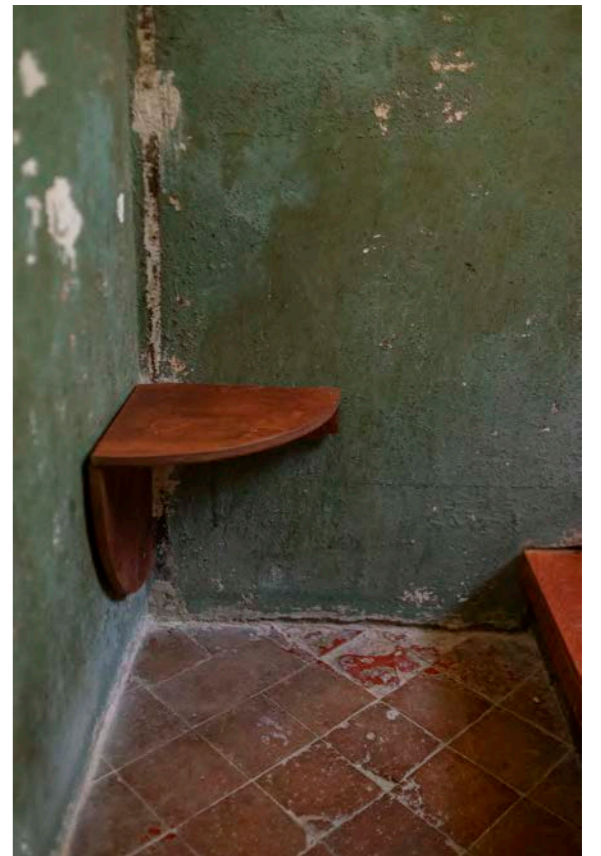
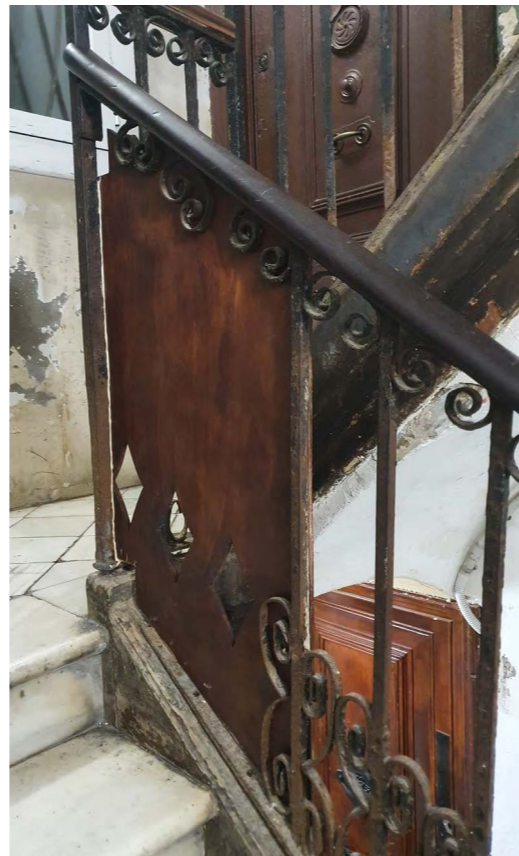



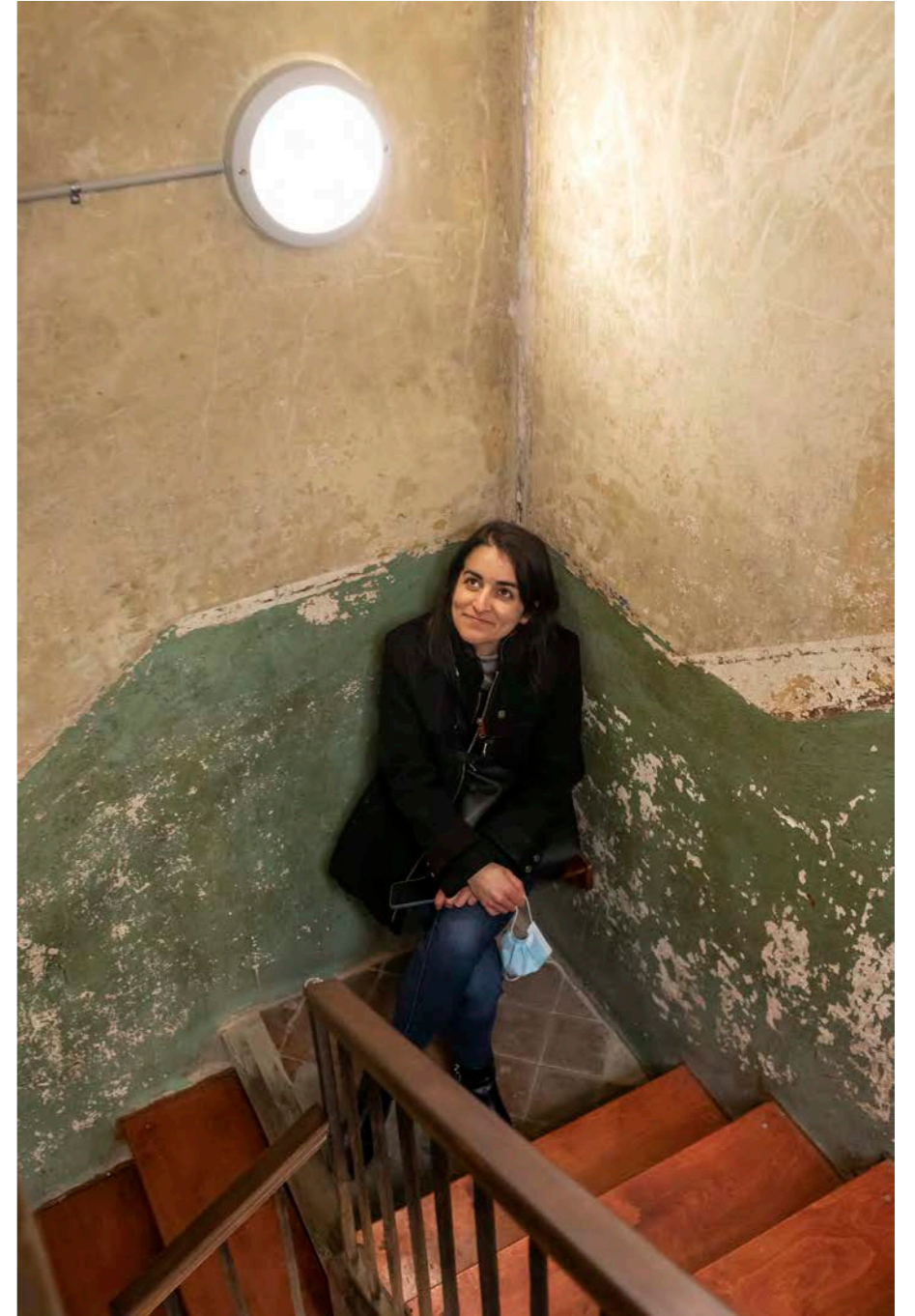
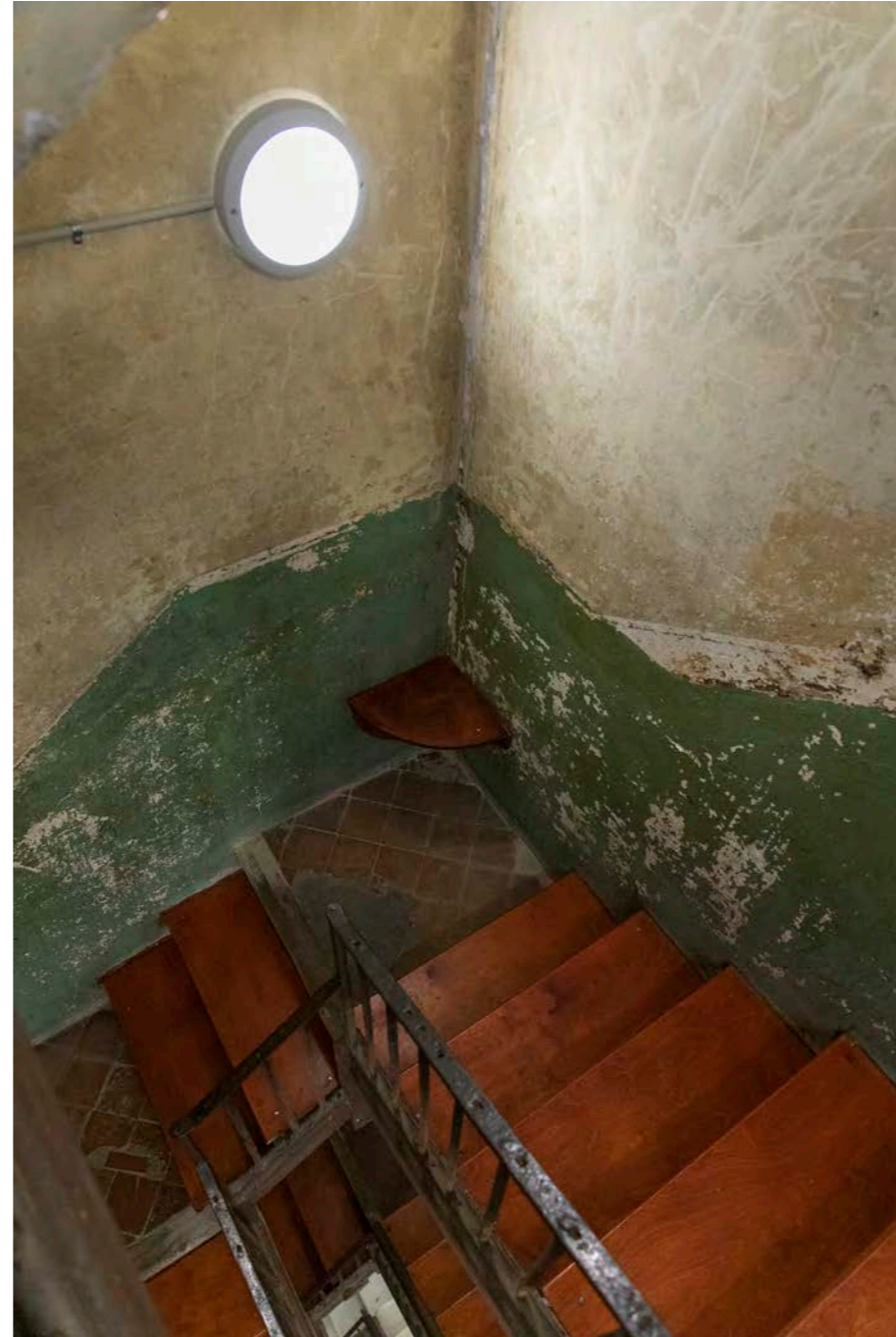
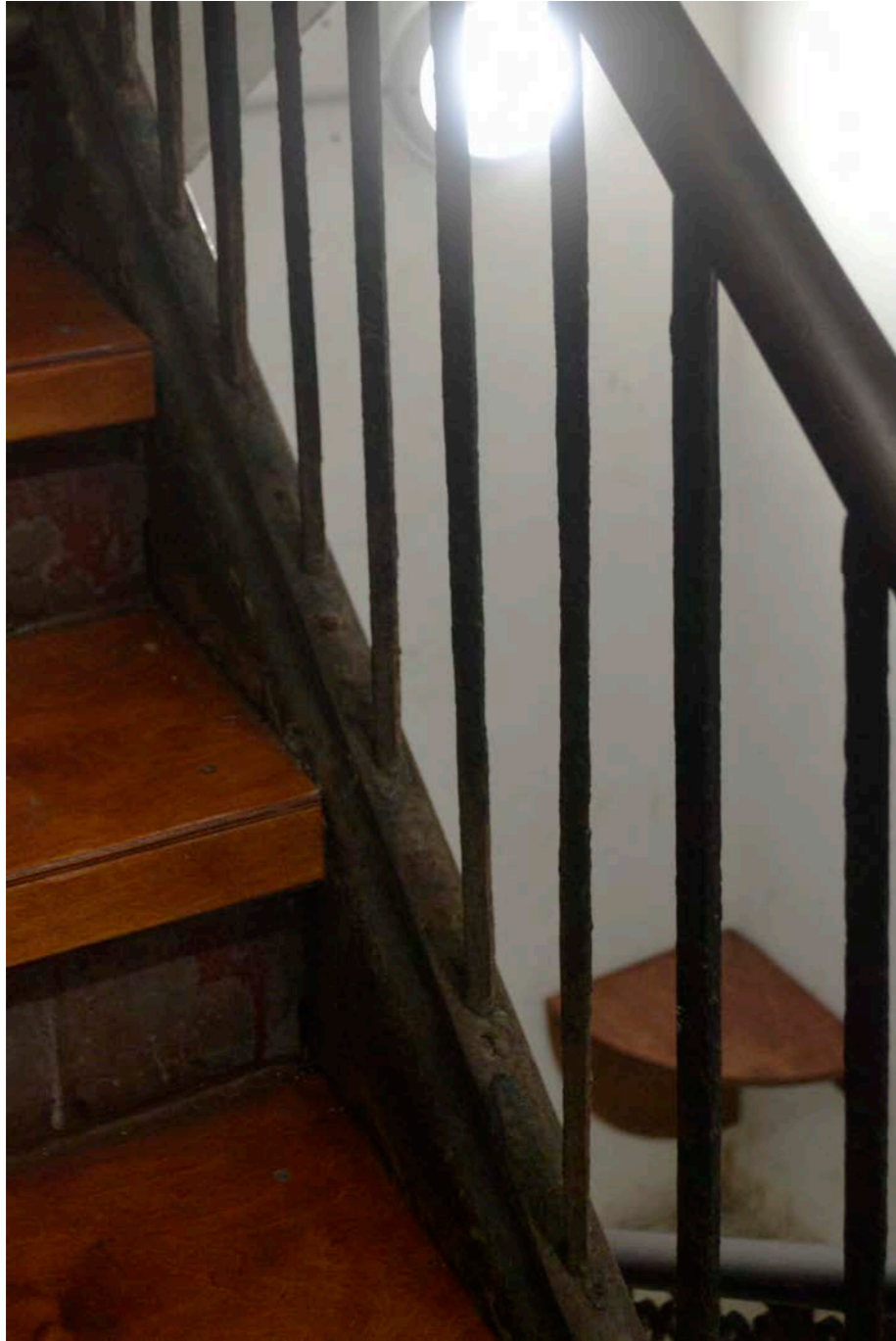

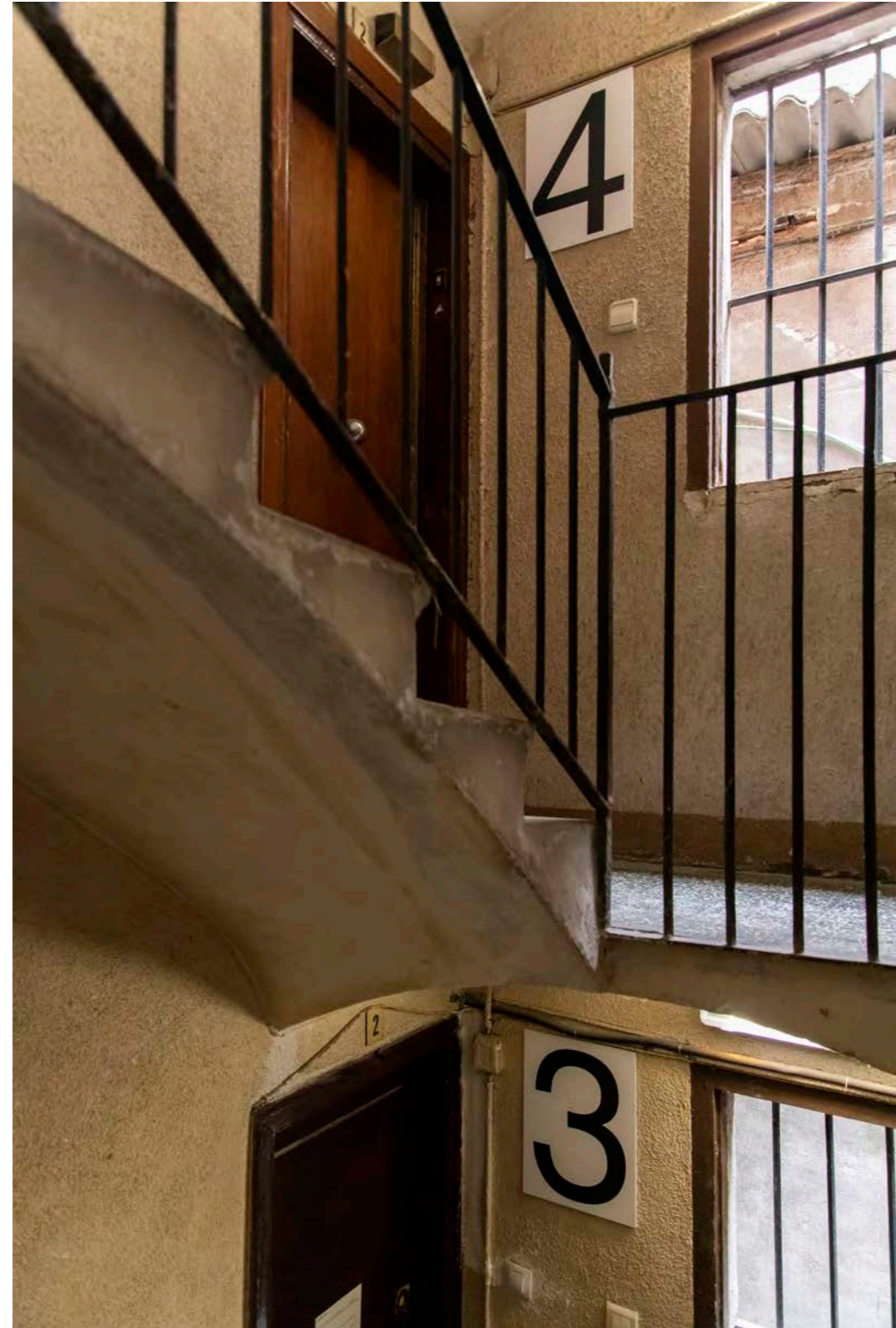
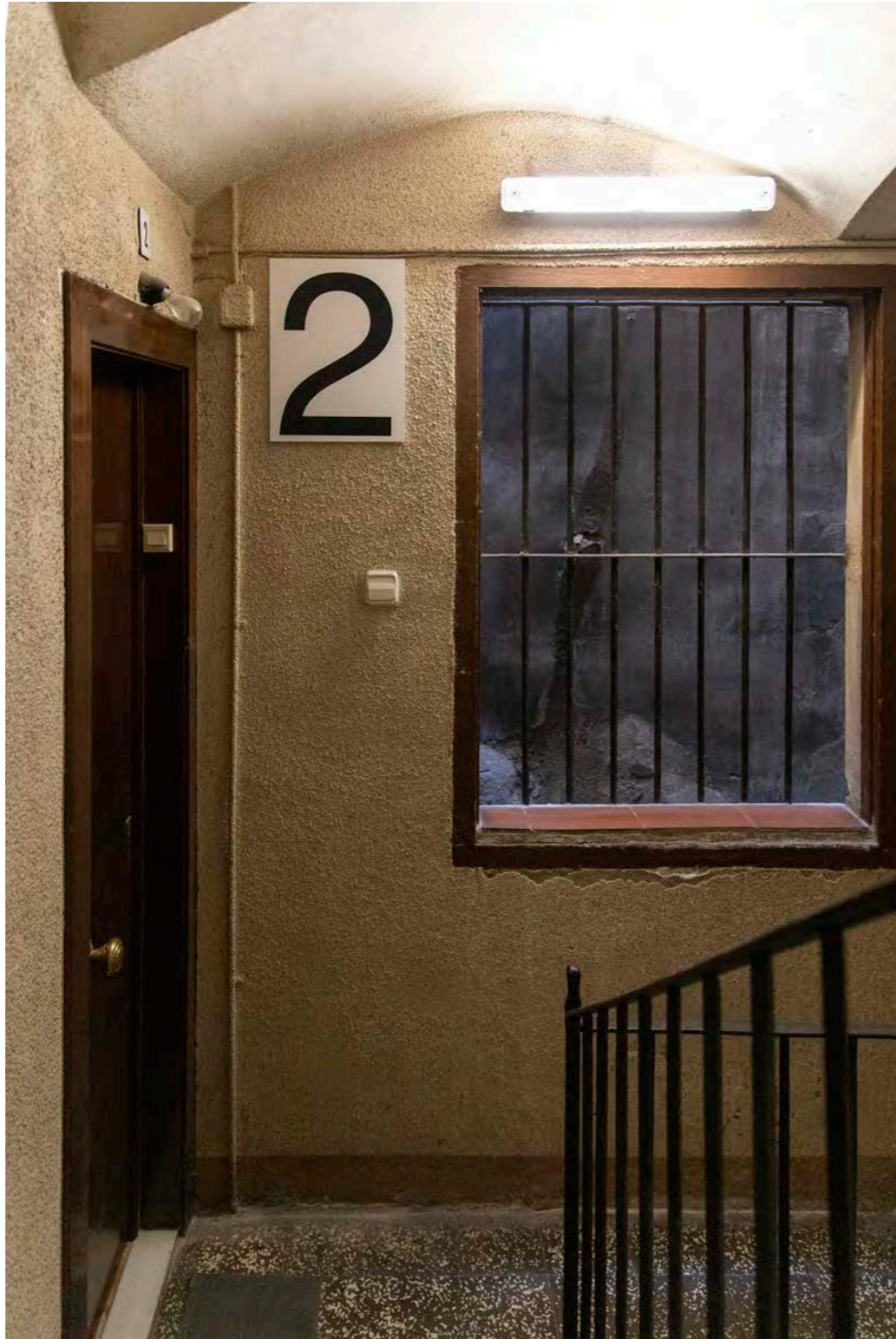

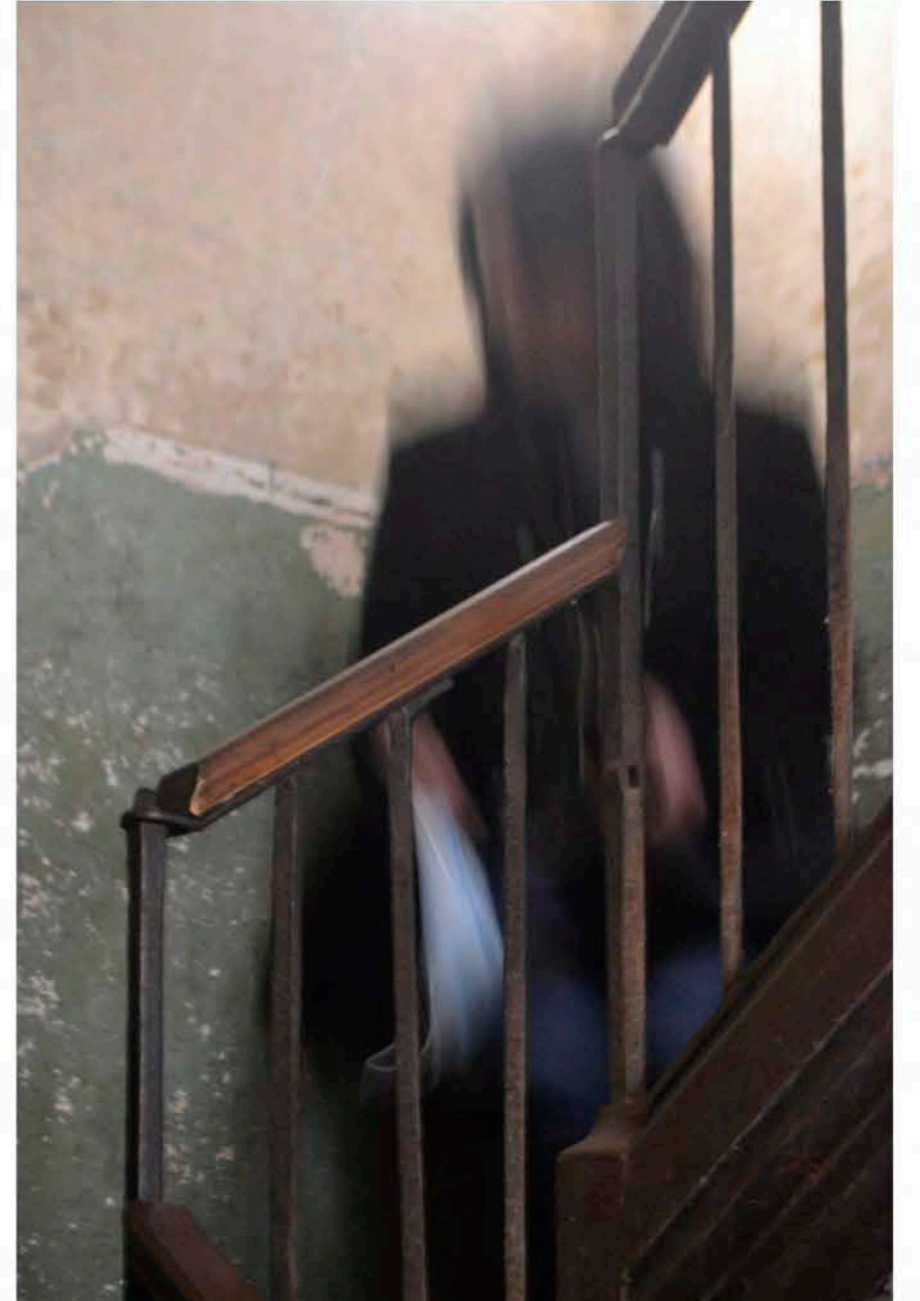

Light, interior air quality and sanitation, safety and sustainability in La Rambla del Raval and Sant Pacià interventions on the staircase.

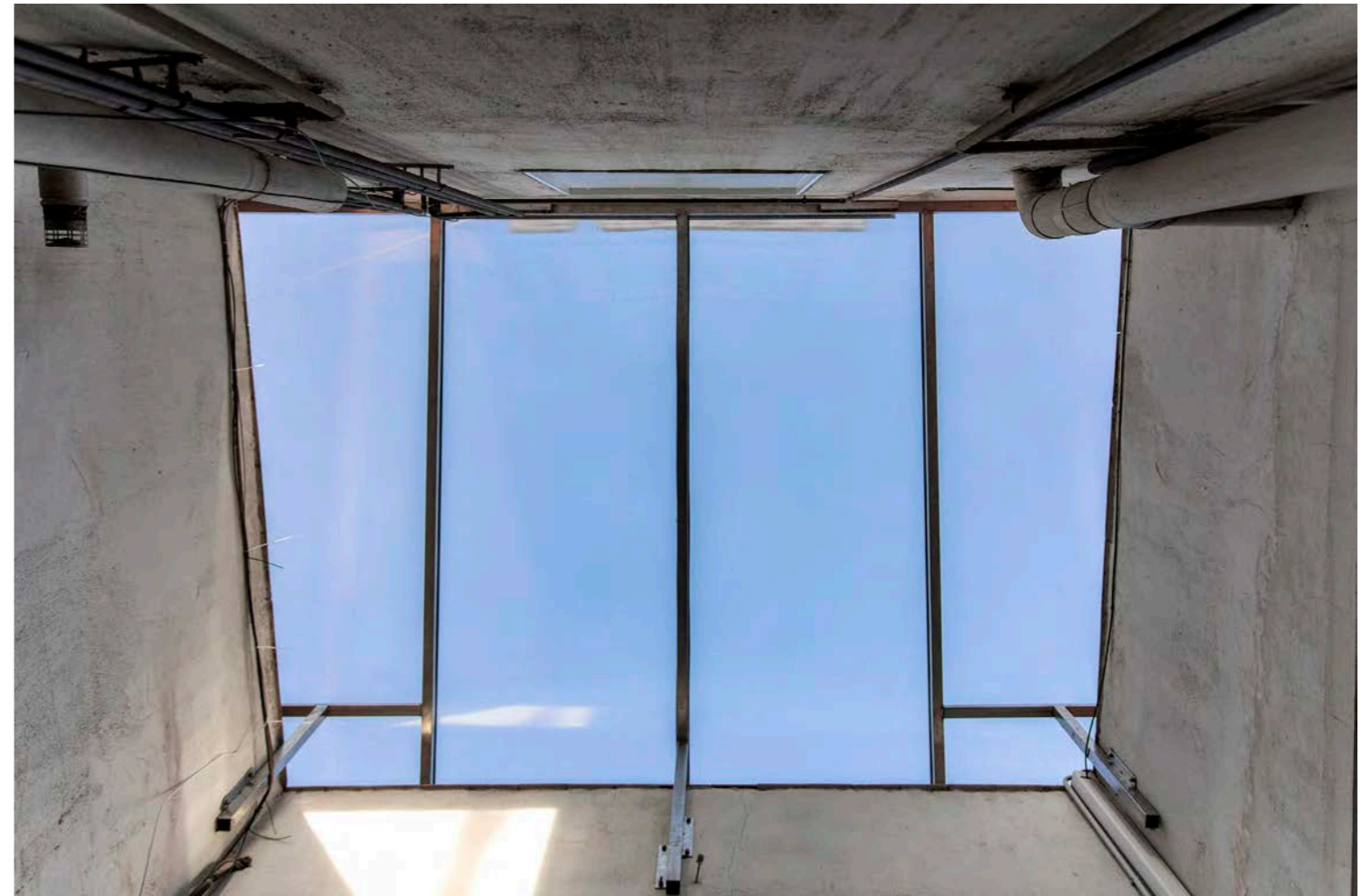

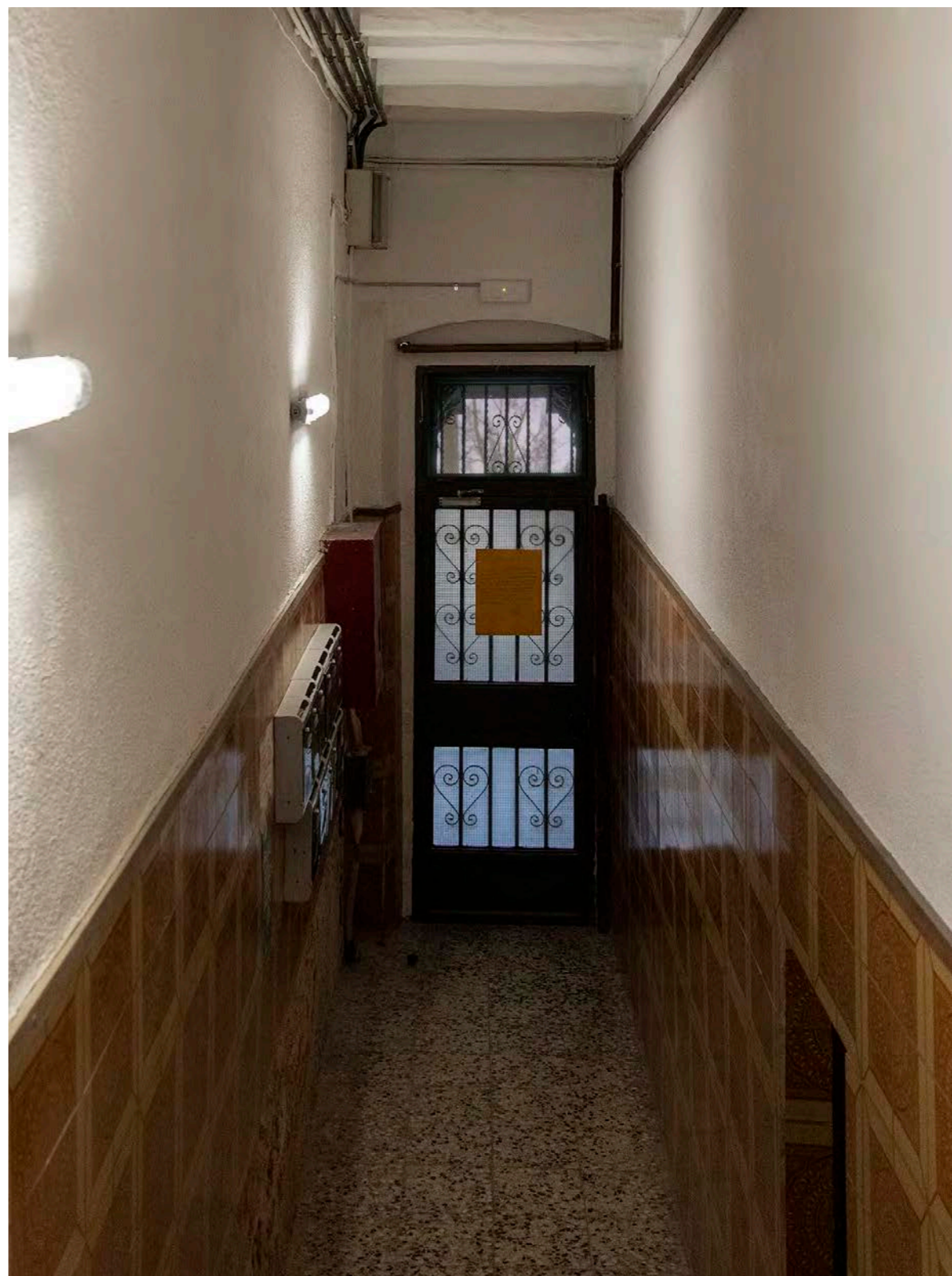
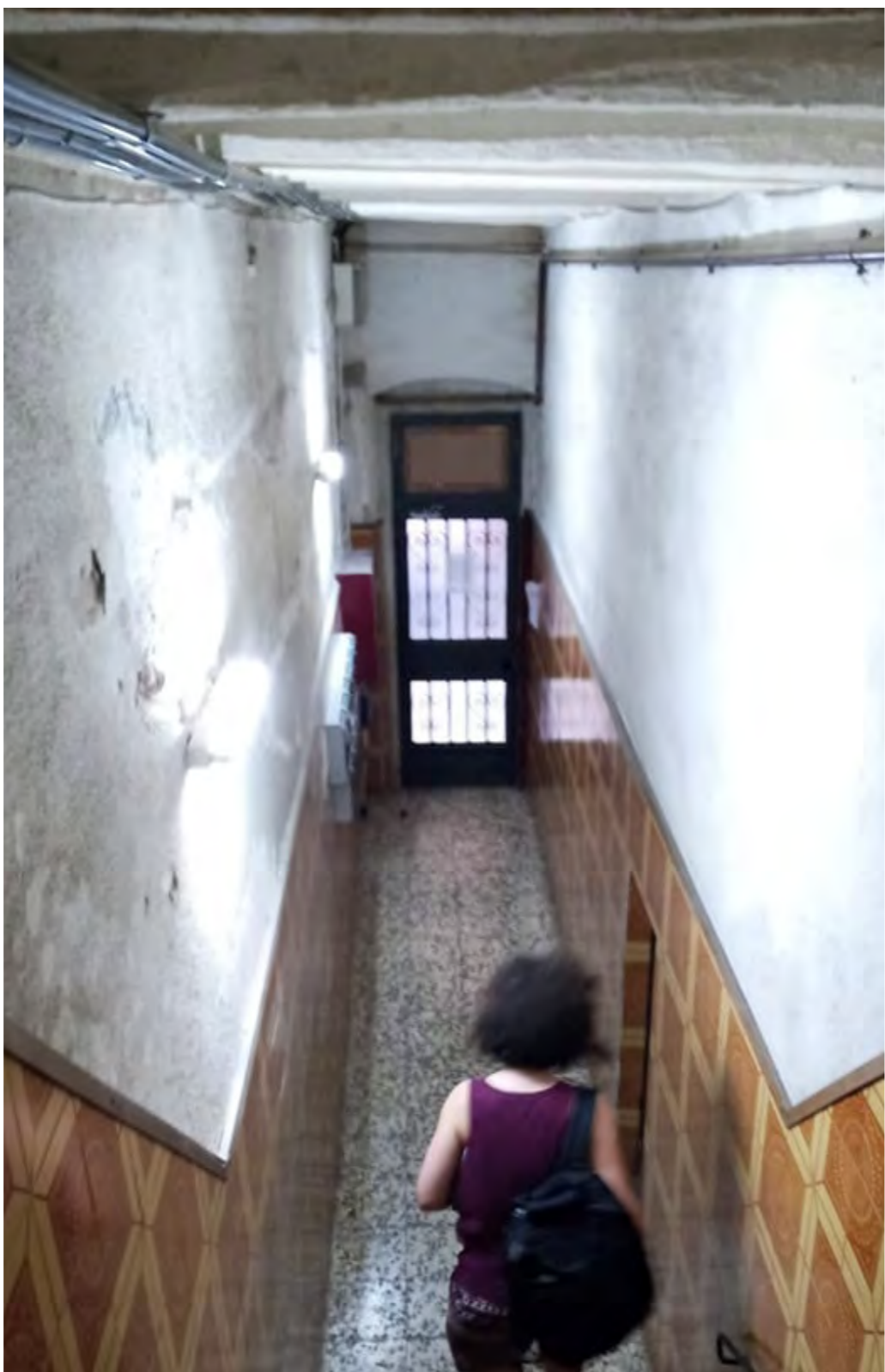



Inclusion, safety, care and health, sustainability and resilience in Carretes, Peu de la Creu and Sant Pacià interventions on the rooftop.

